



Hardware



Find lists of devices supported by the IGEL OS versions, hardware-related articles, and information on IGEL hardware products.



Supported Devices

- [IGEL OS 12 Hardware Support \(see page 4\)](#)
- [IGEL OS 11 Hardware Support \(see page 43\)](#)



IGEL OS 12 Hardware Support

- [Devices Supported by IGEL OS 12 \(see page 5\)](#)
- [Peripherals Supported by IGEL OS 12 \(see page 36\)](#)
- [Limited Device Support for Legacy Devices and Special Use Cases with IGEL OS 12 \(see page 41\)](#)

Devices Supported by IGEL OS 12

Partner Solutions for Peripheral Devices

- ✓ For further supported hardware from IGEL partners, e.g. headsets, see [Peripherals Supported by IGEL OS 12 \(see page 36\)](#).

Requirements for IGEL OS 12

- CPU: 64-bit-capable, Dual Core or more, minimum 1,5 GHz. More than two CPU cores and higher CPU speed may be required if e.g. a Unified Communications optimization is used (client-side media engine). Please refer to the requirements of the solution you are using.
- RAM: Minimum 4 GB; a larger RAM size is recommended if you use any of the following:
 - Unified Communications optimizations (uses a client-side media engine; video resolution \geq 720p)
 - High-resolution graphics output (e.g. 2x 2K, 1x 4K)
 - More than two monitors
- Mass storage: Minimum 8 GB. The following storage media are supported: Hard disk, flash memory, SSD, eMMC, or NVME.
- Graphics chip: Intel, ATI/AMD, or Nvidia
- Network: Ethernet or wireless adapter K14
- Booting from an external device: USB 3.0 or 2.0 port from which the device can boot (alternatively a DVD drive)

Why Min. 4 GB RAM and 8 GB Storage?

Reasons for 4 GB RAM:

- IGEL OS 12 desktop with HTML5-based elements:
 - Tray apps
 - Notification panel
 - Ongoing improvements in regards of modern desktop
- Focus on browser-based applications and multimedia / UC

Reasons for 8 GB storage:

- Background app update
 - During the performed background app update, an app (or several apps) will be loaded in the background.
 - Old apps still exist for an easy downgrade (if needed). This is handled in a quite similar way for the base system (including app dependencies) – for offering (upcoming) possibility to reset the system to the “last known good configuration/system”
- App(s) may need a writeable partition (dynamic allocation)
- Web applications require a lot of disc space / cache, e.g. PWA for Microsoft Teams

Furthermore: Future-proof minimal requirements – no need to increase the minimal requirements for the next years / during the lifetime of IGEL OS 12.

 On modern computers such as secured-core PCs (see e.g. <https://www.microsoft.com/en-us/windows/business/devices?col=secured-core-pcs>), there may be a BIOS setting related to Secure Boot that allows the use of Microsoft's 3rd party UEFI Secure Boot Certificate. The usual description of such a BIOS setting is "Allow Microsoft 3rd Party UEFI CA". This setting must be set to enabled, as IGEL uses the 3rd party certificate to support UEFI Secure Boot. If UEFI Secure Boot is enabled, but "Allow Microsoft 3rd Party UEFI CA" is not enabled, you may be unable to boot IGEL OS Creator or UD Pocket. Similarly, if the setting "Allow Microsoft 3rd Party UEFI CA" is disabled after a previous installation of IGEL OS, IGEL OS will fail to boot. For how to enable the setting, see [Secured-Core PCs: Microsoft 3rd-Party UEFI Certificate for Secure Boot¹](#).

Devices Supported by OSC and UD Pocket with IGEL OS 12

 The following list only includes those devices that are **tested by IGEL** (with each major release of IGEL OS). By no means it implies that the devices which are not included in this list but meet the minimum requirements will not function with IGEL OS: Any x86-64 hardware endpoint device that meets the IGEL-stated minimum hardware requirements for IGEL OS (for example, the processor speed and RAM) can be expected to work adequately with IGEL OS and should be considered a candidate for repurposing from another OS. With an IGEL OS subscription or active maintenance, customers can expect IGEL to make any necessary "best effort" to support, regardless of whether the endpoints in question are specifically listed within the IGEL Knowledge Base or elsewhere (e.g. on the IGEL Ready Showcase at <https://www.igel.com/ready/showcase-categories/endpoints/>).

 HP, Lenovo, and LG device models are available from the factory with pre-installed IGEL OS. Please contact [IGEL Ready²](#) to get information on which device models are available with pre-installed IGEL OS.

 [Fn] keys may not work on some supported and listed laptop/notebook models.

1. <https://kb.igel.com/en/security-safety/current/secured-core-pcs-microsoft-3rd-party-uefi-certific>
2. <https://www.igel.com/technology-partners/>

Dell / Wyse

Name	Device Category	Minimum Memory (RAM) Size	Storage Size	Processor	Supported from IGEL OS Version	Notes	Name Displayed in IGEL System
5070	Thin Client	4 GB	16 GB	Intel Pentium Silver J5005	12.01.110		DELL WYSE 5070 THIN CLIENT
Optiplex 3000	Thin Client	4 GB	32 GB	Intel Celeron N5105	12.01.110	Wake on LAN is not supported.	DELL OPTIPLEX 3000 THIN CLIENT
Optiplex 3000	Thin Client	16 GB	256 GB	Intel Pentium Silver N6005	12.7.1	Wake on LAN (WOL) from S5 (Shutdown) requires to disable the "Deep Sleep" BIOS setting.	Dell Optiplex 3000 Thin Client

Elo

Name	Device Category	Minimum Memory (RAM) Size	Storage Size	Processor	Supported from IGEL OS Version	Name Displayed in IGEL System
i2-Series AiO Display i2 (15 and 22-inch)	All in One	4 GB	18 GB	Intel Celeron J4105	12.01.110	ELO I2

HP

Name	Device Category	Minimum Memory (RAM) Size	Storage Size	Processor	Supported from IGEL OS Version	Wi-Fi Chip	Notes	Name Displayed in IGEL System
HP t540	Thin Client	4 GB	16 GB	AMD Ryzen Embedded R1305G	12.01.110	Intel AC9260 Realtek RTL8852AE		HP t540 Thin Client
HP Pro t550	Thin Client	4 GB	32 GB	Intel Celeron J6412	12.01.110	Realtek RTL8852CE (Supported as of 12.2.0)		HP Pro t550 Thin Client
HP t640	Thin Client	4 GB	16 GB	AMD Ryzen Embedded R1505G	12.01.110	Intel AC9260 Realtek RTL8852AE	This model is not supported with HP USB-C Essential G5 Dock	HP t640 Thin Client
HP Elite t655	Thin Client	8 GB	64 GB	AMD Ryzen Embedded R2314	12.01.110	Realtek RTL8852BE		HP Elite t655 Thin Client
HP mt46	Mobile Thin Client	8 GB	128 GB	AMD Ryzen 3 PRO 4450U	12.01.110			HP mt46 Mobile Thin Client
HP Elite mt645 G7	Mobile Thin Client	8 GB	256 GB	AMD Ryzen 5 5625U	12.01.110	Realtek RTL8852BE	Support for WWAN Intel XMM 7560. System suspend is not supported.	HP Elite mt645 G7 Mobile Thin Client

Name	Device Category	Minimum Memory (RAM) Size	Storage Size	Processor	Supported from IGEL OS Version	Wi-Fi Chip	Notes	Name Displayed in IGEL System
HP t740	Thin Client	8 GB	16 GB	AMD Ryzen Embedded V1756B	12.2.0	Realtek RTL8852 AE		HP t740 Thin Client
HP Pro mt440 G3	Mobile Thin Client	8 GB	128 GB	Intel Celeron 7305	12.2.0	Realtek RTL8852 BE	Support for WWAN Intel XMM 7560 (as of 12.3.2 - tested with HP mt440 G3 BIOS v1.08.00, and Intel XMM7560 firmware v1.16.48)	HP Pro mt440 G3 Mobile Thin Client

Name	Device Category	Minimum Memory (RAM) Size	Storage Size	Processor	Supported from IGEL OS Version	Wi-Fi Chip	Notes	Name Displayed in IGEL System
HP Elite t755	Thin Client	8 GB	128 GB	AMD Ryzen Embedded V2546	12.2.0	Realtek RTL8852 CE (Supported as of 12.2.0)	<p>This model offers no USB-C docking support</p> <p>To optimize the configuration of a multi-monitor setup, see (12.4-en) Troubleshooting: Black Screen When Using Several 4K Displays with Multiple GPUs in IGEL OS 12.</p> <p>Starting from OS version 12.5.1, the model is supported with:</p> <ul style="list-style-type: none"> • Intel i226, 2.5Gbps Ethernet card • Allied Telesis 2914SP Gbps PCIe network adapter with SFP port for Ethernet/SFP/WoL 	HP Elite t755 Thin Client
HP Elite mt645 G8	Mobile Thin Client	16 GB	256 GB	AMD Ryzen-5 7535U, Ryzen-3 7335U	12.4.1	<ul style="list-style-type: none"> • Realtek 8852C E • AMD RZ 616 	<p>WWAN: HP 4000 4G LTE</p> <p>Touchscreen supported (tested model ELAN2513:00)</p>	HP Elite mt645 G8 Mobile Thin Client

Name	Device Category	Mini mum Memory (RAM) Size	Storage Size	Processor	Supported from IGEL OS Version	Wi-Fi Chip	Notes	Name Displayed in IGEL System
HP Elite t660	Thin Client	8 GB	32 GB	Intel RPL-U U300E	12.5.1	Realtek RTL8111 HSH	To configure the device for recording through the rear connection, see Troubleshooting: Headphone Does Not Record through Back of the HP Elite t660 in IGEL OS 12 (see page 102) .	HP Elite t660 Thin Client
HP ProDesk 5 G1i	Thin Client	8 GB	64 GB	Intel N50	12.7.2 PR1	AMD Mediatek RZ616		HP ProDesk 5 G1i
HP ProDesk 5 G1i	Thin Client	16 GB	256 GB	Intel N97	12.7.2 PR1	AX211		HP ProDesk 5 G1i

HP Docking Stations

Name	Supported from IGEL OS Version	Notes
HP USB-C Docking Station G5	12.2.0	Wake-on-LAN is supported from OS version 12.4.2 and with suspend mode only. Tested with: <ul style="list-style-type: none"> • HP Pro t550 • HP Elite t655 • HP Pro mt440 G3 • HP Elite mt645 G7 • HP Elite mt645 G8
HP USB-C G5 Essential Dock	12.2.0	Not supported with HP t640.

Name	Supported from IGEL OS Version	Notes
HP Thunderbolt 4 100W G6 Dock	12.8.0	Tested with: <ul style="list-style-type: none"> • HP Elite t660 • HP Elite t755 • HP Elite mt645 G8
HP Thunderbolt 4 Ultra 180/280W G6 Dock	12.8.0	Tested with: <ul style="list-style-type: none"> • HP Elite t660 • HP Elite t755 • HP Elite mt645 G8

IGEL

Product Line	Device Category	Hardware ID	Memory (RAM)	Storage	Supported from IGEL OS Version	Notes	Name Displayed in IGEL System
UD3	UD3 M350C ³	60	4 GB	8 GB	12.01.110		IGEL M350C
UD7	UD7 H860C ⁴	20	8 GB	8 GB	12.01.110	System suspend is not supported.	IGEL H860C
UD Pocket 2	UD Pocket 2 (see page 62)						

Lenovo

Name	Device Category	Minimum Memory (RAM) Size	Storage Size	Processor	Wi-Fi Chip	Supported from IGEL OS Version	Notes	Name Displayed in IGEL System
ThinkCentre M70q Gen 3	Desktop PC	16 GB	256 GB	Intel Core i5-12500T	Intel AX201	12.01.110		Lenovo ThinkCentre M70q Gen 3

3. <https://kb.igel.com/knowledge-base-archive/current/>

4. <https://kb.igel.com/knowledge-base-archive/current/>

Name	Device Category	Minimum Memory (RAM) Size	Storage Size	Processor	Wi-Fi Chip	Supported from IGEL OS Version	Notes	Name Displayed in IGEL System
ThinkCentre M75q Gen 2	Desktop PC	4 GB	128 GB	AMD Ryzen 3 Pro 5350GE	Intel AX200	12.01.110		Lenovo ThinkCentre M75q Gen 2
K14 Gen 1 AMD	Laptop/ Notebook	8 GB	256 GB	AMD Ryzen 5 PRO 5650U	Mediatek MT7921	12.01.110	Internal microphone is not working. Wake on LAN is not supported. System suspend is supported as of IGEL OS 12.01.140.1.	Lenovo K14 Gen 1 (AMD)
ThinkPad L14 Gen 3 AMD	Laptop/ Notebook	16 GB	256 GB	AMD Ryzen 5 5625U	AMD RZ616 2X2AX (WiFi 6E)	12.01.110	without LTE support	Lenovo ThinkPad L14 Gen 3 (AMD)
ThinkPad L14 Gen 3 Intel	Laptop/ Notebook	16 GB	512 GB	Intel Core i5-1235U	Intel AX201	12.01.110	WWAN: Quectel EM05-G 4G CAT4 (supported with IGEL OS 12.2 or higher)	Lenovo ThinkPad L14 Gen 3 (Intel)
K14 Gen 1 Intel	Laptop/ Notebook	16 GB	256 GB	Intel Core i5-1135G7	Intel AX210 (WiFi/BT)	12.2.0		Lenovo K14 Gen 1 (Intel)

Name	Device Category	Minimum Memory (RAM) Size	Storage Size	Processor	Wi-Fi Chip	Supported from IGEL OS Version	Notes	Name Displayed in IGEL System
ThinkEdge SE10	Thin Client	8 GB	1 TB	Intel Atom x6425REN	MediaTek MT7921LE	12.2.0		Lenovo ThinkEdge SE10
ThinkEdge SE10	Thin Client	8 GB	256 GB	Intel Atom x6214RE	Intel AX210	12.2.0		Lenovo ThinkEdge SE10
ThinkCentre Neo50q Gen 4	Thin Client	8 GB	256 GB	Intel Core i3-1215UE	Wi-Fi 6 RTL8852B	12.2.0		Lenovo ThinkCentre Neo50q Gen 4
ThinkCentre Neo50q Gen 4	Thin Client	4 GB	256 GB	Intel Celeron 7305	Wi-Fi 6 AX201	12.2.0		Lenovo ThinkCentre Neo50q Gen 4
ThinkPad L14 Gen 4 Intel	Laptop/ Notebook	8 GB	256 GB	Intel Core i3-1315U	Intel AX211	12.2.1	WWAN: Quectel EM05-G 4G CAT4	Lenovo ThinkPad L14 Gen 4 (Intel)
ThinkPad L14 Gen 4 AMD	Laptop/ Notebook	8 GB	256 GB	AMD Ryzen 3 PRO 7330U	<ul style="list-style-type: none"> • AMD RZ616 • Realtek RTL8852CE 	12.2.1	WWAN: Quectel EM05-G 4G CAT4	Lenovo ThinkPad L14 Gen 4 (AMD)
ThinkPad L15 Gen 4 Intel	Laptop/ Notebook	8 GB	256 GB	Intel Core i3-1315U	Intel AX211	12.2.1	WWAN: Quectel EM05-G 4G CAT4	Lenovo ThinkPad L15 Gen 4 (Intel)

Name	Device Category	Minimum Memory (RAM) Size	Storage Size	Processor	Wi-Fi Chip	Supported from IGEL OS Version	Notes	Name Displayed in IGEL System
ThinkPad L15 Gen 4 AMD	Laptop/ Notebook	8 GB	256 GB	AMD Ryzen 3 PRO 7330U	<ul style="list-style-type: none"> • AMD RZ616 • Realtek RTL8852CE 	12.2.1	WWAN: Quectel EM05-G 4G CAT4	Lenovo ThinkPad L15 Gen 4 (AMD)
ThinkStation P3 Tiny	Desktop PC	16 GB	512 GB	Intel Core i5-13400T	Intel AX211	12.2.1		Lenovo ThinkStation P3 Tiny
ThinkPad L13 Gen 4 Intel	Laptop/ Notebook	8 GB	256 GB	Intel Core i3-1315U	Intel AX201	12.3.1	WWAN: Quectel EM05-G 4G CAT4 No integrated LAN	Lenovo ThinkPad L13 Gen 4 (Intel)
ThinkPad L13 Gen 4 AMD	Laptop/ Notebook	16 GB	256 GB	AMD Ryzen 3 PRO 7330U	AMD RZ616	12.3.1	WWAN: Quectel EM05-G 4G CAT4 No integrated LAN	Lenovo ThinkPad L13 Gen 4 (AMD)

Name	Device Category	Minimum Memory (RAM) Size	Storage Size	Processor	Wi-Fi Chip	Supported from IGEL OS Version	Notes	Name Displayed in IGEL System
ThinkPad L14 Gen 5 Intel	Laptop/ Notebook	16 GB	256 GB	Intel Core Ultra 5 135U	Intel AX211	12.4.1	WWAN: <ul style="list-style-type: none"> • Quectel EM061K-GL • Quectel EM160R-GL Gen2 (supported with IGEL OS 12.5.1 or higher) 	Lenovo ThinkPad L14 Gen 5 (Intel)
ThinkPad L14 Gen 5 AMD	Laptop/ Notebook	32 GB	2 TB	AMD Ryzen 3 Pro 7333U	Qualcom NFA765	12.4.2	WWAN: <ul style="list-style-type: none"> • Quectel EM061K-GL • Quectel EM160R-GL Gen2 (supported with IGEL OS 12.5.1 or higher) 	Lenovo ThinkPad L14 Gen 5 (AMD)
ThinkCentre M70q Gen 5	Desktop PC	8 GB	256 GB	Intel Core i3-14100T	Intel AX211	12.4.2		Lenovo ThinkCentre M70q Gen 5
ThinkCentre M75q Gen 5	Desktop PC	8 GB	256 GB	AMD Ryzen 3 Pro 8300GE	Realtek RTL8852CE	12.4.2		Lenovo ThinkCentre M75q Gen 5
ThinkPad L13 Gen 5 Intel	Laptop/ Notebook	8 GB	256 GB	Intel Core Ultra 125U	Intel AX211	12.5.1	WWAN: <ul style="list-style-type: none"> • Quectel EM061K-GL 	Lenovo ThinkPad L13 Gen 5 (Intel)

Name	Device Category	Minimum Memory (RAM) Size	Storage Size	Processor	Wi-Fi Chip	Supported from IGEL OS Version	Notes	Name Displayed in IGEL System
ThinkPad L16 Gen 1 Intel	Laptop/ Notebook	8 GB	256 GB	Intel Core Ultra 125U	Intel AX211	12.5.1	WWAN: <ul style="list-style-type: none"> • Quectel EM061K-GL • Quectel EM160R-GL Gen2 	Lenovo ThinkPad L16 Gen 1 (Intel)
ThinkPad L16 Gen 1 AMD	Laptop/ Notebook	8 GB	256 GB	AMD Ryzen 3 Pro 7335U	Qualcom NFA725	12.5.1	WWAN: <ul style="list-style-type: none"> • Quectel EM061K-GL • Quectel EM160R-GL Gen2 	Lenovo ThinkPad L16 Gen 1 (AMD)
ThinkCentre M70q Gen 6	Desktop PC	16 GB	512 GB	Intel Core Ultra 5 235T	RTL8852CE	12.7		Lenovo ThinkCentre M70q Gen 6
ThinkCentre M70q Gen 6	Desktop PC	8 GB	256 GB	Intel Core Ultra 5 225T	AX211	12.7		Lenovo ThinkCentre M70q Gen 6
ThinkCentre M70q Gen 6	Desktop PC	8 GB	256 GB	Intel Core Ultra 5 245T	Intel AX201	12.7.1		Lenovo ThinkCentre M70q Gen 6
ThinkCentre M625q	Thin Client	8 GB	128 GB	AMD A4-9120e	QCA6174 802.11ac	12.7.1		Lenovo ThinkCentre M625q
V100q	Thin Client	8 GB	256 GB	Intel N100	AX201	12.7.2 PR1		Lenovo V100q

Name	Device Category	Minimum Memory (RAM) Size	Storage Size	Processor	Wi-Fi Chip	Supported from IGEL OS Version	Notes	Name Displayed in IGEL System
ThinkStation P3 Ultra SFF Gen 2	Desktop PC	8 GB	256 GB	Intel Core Ultra 5 235	-	12.7.2 PR1	Tested with two AXIOM 1Gbps Single-Port SFP Fiber NICs (AXG95712 - PCIe 2.0)	ThinkStation P3 Ultra SFF Gen 2

Name	Device Category	Minimum Memory (RAM) Size	Storage Size	Processor	Wi-Fi Chip	Supported from IGEL OS Version	Notes	Name Displayed in IGEL System
500w 2-in-1 Gen 5	Laptop/ Notebook	8 GB	256 GB	Intel N150	Intel AX211	12.7.4	<p>Added support for F1-F11 function keys for Lenovo 500w 2-in-1 Gen 5:</p> <p>More...</p> <ul style="list-style-type: none"> • F1: Mute audio. • F2/F3: Increase/decrease audio. • F4: Mute microphone. • F5/F6: Decrease/increase brightness. • F7: Display configuration; open IGEL display configuration. • F8: Airplane mode. • F9: Open settings; open IGEL Setup. 	Lenovo 500w 2-in-1 Gen 5

Name	Device Category	Minimum Memory (RAM) Size	Storage Size	Processor	Wi-Fi Chip	Supported from IGEL OS Version	Notes	Name Displayed in IGEL System
							<ul style="list-style-type: none"> • F10: Lock screen; screen is locked if local user password is set. See Local User Login in IGEL OS 12⁵. • F11: Switch windows; cycle between open windows if 'Switch focus to next window' hotkey is enabled (by default). Otherwise, don't do anything. 	

5. <https://kb.igel.com/en/igel-os-base-system/current/local-user-login-in-igel-os-12>

Name	Device Category	Minimum Memory (RAM) Size	Storage Size	Processor	Wi-Fi Chip	Supported from IGEL OS Version	Notes	Name Displayed in IGEL System
13w 2-in-1 Gen 3	Laptop/ Notebook	8 GB	256 GB	Intel Core 3 100U	Intel AX211	12.7.4	<p>Added support for F1-F11 function keys for Lenovo 13w 2-in-1 Gen 3:</p> <p>More...</p> <ul style="list-style-type: none"> • F1: Mute audio. • F2/F3: Increase/ decrease audio. • F4: Mute microphone. • F5/F6: Decrease/ increase brightness. • F7: Display configuration; open IGEL display configuration. • F8: Airplane mode. • F9: Open settings; open IGEL Setup. 	Lenovo 13w 2-in-1 Gen 3

Name	Device Category	Minimum Memory (RAM) Size	Storage Size	Processor	Wi-Fi Chip	Supported from IGEL OS Version	Notes	Name Displayed in IGEL System
							<ul style="list-style-type: none"> • F10: Lock screen; the screen is locked if local user password is set. See Local User Login in IGEL OS 12⁶. • F11: Switch windows; cycle between open windows if 'Switch focus to next window' hotkey is enabled (by default). Otherwise, don't do anything. 	
ThinkPad L16 Gen 2 Intel	Laptop/ Notebook	16 GB	256 GB	Intel Core Ultra 5 225U	Intel AX211	12.7.4		Lenovo ThinkPad L16 Gen 2 (Intel)

6. <https://kb.igel.com/en/igel-os-base-system/current/local-user-login-in-igel-os-12>

Name	Device Category	Minimum Memory (RAM) Size	Storage Size	Processor	Wi-Fi Chip	Supported from IGEL OS Version	Notes	Name Displayed in IGEL System
ThinkPad T14 Gen 6 AMD	Laptop/ Notebook	32 GB	1024GB	AMD Ryzen AI 7 PRO 350	MediaTek MT7925	12.7.4	<p>Support for WWAN Quectel EM160R-GL and Quectel RM520N-GL (as of 12.7.5)</p> <p>Added support for function keys for Lenovo ThinkPad T14 Gen 6 AMD:</p> <p>More...</p> <ul style="list-style-type: none"> • F1: Volume mute • F2: Volume down • F3: Volume up • F4: Microphone mute • F5: Brightness down • F6: Brightness up • F7: Display configuration • F8: Mode (power) • F9: Screenshot (+CTRL) 	Lenovo ThinkPad T14 Gen 6 (AMD)

Name	Device Category	Minimum Memory (RAM) Size	Storage Size	Processor	Wi-Fi Chip	Supported from IGEL OS Version	Notes	Name Displayed in IGEL System
							<ul style="list-style-type: none"> • F10: Snipping tool (+CTRL) • F12: Jump to browser URL (+CTRL) 	
ThinkCentre Neo 50q Gen 5	Thin Client	16 GB	256 GB	Intel Core i3-1315U	Intel AX211	12.7.5		Lenovo ThinkCentre Neo 50q Gen 5
ThinkStation P3 Tiny Gen 2	Thin Client	16 GB	256 GB	Intel Core Ultra 5 225	Intel AX1775	12.7.5		Lenovo ThinkStation P3 Tiny Gen 2

Name	Device Category	Minimum Memory (RAM) Size	Storage Size	Processor	Wi-Fi Chip	Supported from IGEL OS Version	Notes	Name Displayed in IGEL System
ThinkPad L14 Gen 6 (AMD)	Laptop/ Notebook	16 GB	256 GB	AMD Ryzen 3 PRO 210	MediaTek MT7925	12.8.0	<p>Added function key support for Lenovo L14 Gen 6 (AMD):</p> <p>More...</p> <ul style="list-style-type: none"> • F1: Volume mute • F2: Volume down • F3: Volume up • F4: Microphone mute • F5: Brightness down • F6: Brightness up • F7: Display configuration • F8: Mode (power) • F9: Screenshot (+CTRL) • F10: Snipping tool (+CTRL) • F12: Jump to browser URL (+CTRL) 	Lenovo ThinkPad L14 Gen 6 (AMD)

Name	Device Category	Minimum Memory (RAM) Size	Storage Size	Processor	Wi-Fi Chip	Supported from IGEL OS Version	Notes	Name Displayed in IGEL System
ThinkPad L14 Gen 6 (Intel)	Laptop/ Notebook	16 GB	256 GB	Intel Core Ultra 5 225U	Intel AX211	12.8.0	<p>Added function key support for Lenovo ThinkPad L14 Gen 6 (Intel):</p> <p>More...</p> <ul style="list-style-type: none"> • F1: Volume mute • F2: Volume down • F3: Volume up • F4: Microphone mute • F5: Brightness down • F6: Brightness up • F7: Display configuration • F8: Mode (power) • F9: Screenshot (+CTRL) • F10: Snipping tool (+CTRL) • F12: Jump to browser URL (+CTRL) 	Lenovo ThinkPad L14 Gen 6 (Intel)

Name	Device Category	Minimum Memory (RAM) Size	Storage Size	Processor	Wi-Fi Chip	Supported from IGEL OS Version	Notes	Name Displayed in IGEL System
ThinkPad L13 Gen 6 (AMD)	Laptop/ Notebook	16 GB	256 GB	AMD Ryzen 3 PRO 210	MediaTek MT7925	12.8.0	<p>Added function key support for Lenovo L13 Gen 6 (AMD):</p> <p>More...</p> <ul style="list-style-type: none"> • F1: Volume mute • F2: Volume down • F3: Volume up • F4: Microphone mute • F5: Brightness down • F6: Brightness up • F7: Display configuration • F8: Mode (power) • F9: Screenshot (+CTRL) • F10: Snipping tool (+CTRL) • F12: Jump to browser URL (+CTRL) 	Lenovo ThinkPad L13 Gen 6 (AMD)

Name	Device Category	Minimum Memory (RAM) Size	Storage Size	Processor	Wi-Fi Chip	Supported from IGEL OS Version	Notes	Name Displayed in IGEL System
ThinkPad L13 Gen 6 (Intel)	Laptop/ Notebook	16 GB	256 GB	Intel Core Ultra 5 225U	Intel AX211	12.8.0	<p>Added function key support for Lenovo ThinkPad L13 Gen 6 (Intel):</p> <p>More...</p> <ul style="list-style-type: none"> • F1: Volume mute • F2: Volume down • F3: Volume up • F4: Microphone mute • F5: Brightness down • F6: Brightness up • F7: Display configuration • F8: Mode (power) • F9: Screenshot (+CTRL) • F10: Snipping tool (+CTRL) • F12: Jump to browser URL (+CTRL) 	Lenovo ThinkPad L13 Gen 6 (Intel)

Name	Device Category	Minimum Memory (RAM) Size	Storage Size	Processor	Wi-Fi Chip	Supported from IGEL OS Version	Notes	Name Displayed in IGEL System
ThinkPad L13 2-in-1 Gen 6 (Intel)	Laptop/ Notebook	16 GB	256 GB	Intel Core Ultra 5 225U	Intel AX211	12.8.0	<p>Added function key support for Lenovo L13 2-in-1 Gen 6 (Intel):</p> <p>More...</p> <ul style="list-style-type: none"> • F1: Volume mute • F2: Volume down • F3: Volume up • F4: Microphone mute • F5: Brightness down • F6: Brightness up • F7: Display configuration • F8: Mode (power) • F9: Screenshot (+CTRL) • F10: Snipping tool (+CTRL) • F12: Jump to browser URL (+CTRL) 	Lenovo ThinkPad L13 2-in-1 Gen 6 (Intel)

Name	Device Category	Minimum Memory (RAM) Size	Storage Size	Processor	Wi-Fi Chip	Supported from IGEL OS Version	Notes	Name Displayed in IGEL System
ThinkPad L16 Gen 2 (AMD)	Laptop/ Notebook	16 GB	256 GB	AMD Ryzen 3 PRO 210	MediaTek MT7925	12.8.0		Lenovo ThinkPad L16 Gen 2 (AMD)

Lenovo Docking Stations

Name	Supported from IGEL OS Version	Notes
ThinkPad USB-C Hybrid Dock	12.2.0	Wake-on-LAN is supported from IGEL OS version 12.4.2 and with suspend mode only. Tested with: <ul style="list-style-type: none"> • ThinkPad L14 Gen5 Intel/AMD
Universal USB-C Dock	12.2.0	Wake-on-LAN is supported from IGEL OS version 12.4.2 and with suspend mode only. Tested with: <ul style="list-style-type: none"> • Neo50q Gen4 Celeron • ThinkPad L13 Gen4 Intel • ThinkPad L14 Gen4 AMD • ThinkPad L14 Gen5 Intel/AMD • ThinkPad L16 Gen1 Intel/AMD • ThinkPad L13 Gen5 Intel
	12.8.0	<ul style="list-style-type: none"> • ThinkPad L13 Gen 6 (AMD) • ThinkPad L13 Gen 6 (Intel) • ThinkPad L13 2-in-1 Gen 6 (Intel) • ThinkPad L14 Gen 6 (AMD)

Lenovo USB-C to Ethernet Adapter

Name	Supported from IGEL OS Version	Supported with
USB-C to Ethernet Adapter	12.3.2	<ul style="list-style-type: none"> • ThinkPad L13 Gen4 Intel/AMD • ThinkPad L13 Gen5 Intel

LG

Name	Device Category	Minimum Memory (RAM) Size	Storage Size	Processor	Wi-Fi Chip	Supported from IGEL OS Version	Notes	Name Displayed in IGEL System
CL600	Thin Client	4 GB	16 GB	Intel Celeron J4105		12.01.10		LG CL600
CQ600	Thin Client	4 GB	16 GB	Intel Celeron N5105		12.01.10		LG CQ60x series
24CQ650	All in One	4 GB	16 GB	Intel Celeron N5105		12.01.10		LG 24CQ65x series
24CN650	All in One	8 GB	16 GB	Intel Celeron J4105		12.01.10	System suspend is not supported.	LG 24CN65x series
34CN650	All in One	4 GB	16 GB	Intel Celeron J4105		12.01.10	System suspend is not supported. Headset mic via jack is not working	LG 34CN65x series
CQ601	Thin Client	4 GB	16 GB	Intel Pentium Silver N6005		12.2.0		LG CQ60x series
24CR670	All in One	4 GB	16 GB	Intel Celeron N5105		12.2.1		LG 24CR67x series

Name	Device Category	Minimum Memory (RAM) Size	Storage Size	Processor	Wi-Fi Chip	Supported from IGEL OS Version	Notes	Name Displayed in IGEL System
27CQ650	All in One	4 GB	16 GB	Intel Celeron N5105		12.3.0		LG 27CQ65x series
34CR650	All in One	4 GB	16 GB	Intel Celeron N5105		12.3.0		LG 34CR65x series
gram 14ZT90R	Mobile Thin Client	8GB	256GB	Intel i3-1315U	Intel AX211	12.4.2		LG gram 14ZT90R
gram 15ZT90R	Mobile Thin Client	8GB	256GB	Intel i3-1315U	Intel AX211	12.4.2		LG gram 15ZT90R
gram 17ZT90R	Mobile Thin Client	8GB	256GB	Intel i3-1315U	Intel AX211	12.4.2		LG gram 17ZT90R

Name	Device Category	Minimum Memory (RAM) Size	Storage Size	Processor	Wi-Fi Chip	Supported from IGEL OS Version	Notes	Name Displayed in IGEL System
gram 14ZD90RU / 14Z90RU	Notebook	16 GB	512 GB	Intel Core i5-1334U	Intel AX211	12.7.2 PR1	<p>Added special function key support for LG Gram 14Z90RU:</p> <p>More...</p> <ul style="list-style-type: none"> • Fn+F2: Brightness down • Fn+F3: Brightness up • Fn+F5: Touchpad on/off • Fn+F6: Airplane mode on/off • Fn+F7: Display configuration • Fn+F8: Keyboard backlight • Fn+F9: Reader mode • Fn+F10: Volume off • Fn+F11: Volume down • Fn+F12: Volume up 	LG Gram 14Z90RU
gram Book 15UT50T	Mobile Thin Client	16 GB	256 GB	Intel Core i3-1315U	AX201	12.7.4	<ul style="list-style-type: none"> • The microphone of headsets connected to the headphone jack is not detected. • The following function keys are currently not supported: <p>More...</p> <ul style="list-style-type: none"> • Fn + F1 • Fn + F4 • Fn + F5 • Fn + F7 • Fn + F8 • Fn + F9 	LG gram Book 15UT50T

Name	Device Category	Minimum Memory (RAM) Size	Storage Size	Processor	Wi-Fi Chip	Supported from IGEL OS Version	Notes	Name Displayed in IGEL System
24CR660	All in One	8 GB	16 GB	Intel Celeron N5105	Intel AX201	12.7.5		LG 24CR66x series
24CR661	All in One	8 GB	16 GB	Intel Pentium Silver N6005	Intel AX201	12.7.5		LG 24CR66x series

LG Monitor with the Integrated Docking Station

Name	Supported from IGEL OS Version	Notes
LG FHD Business Monitor 24BA850-B	12.8.0	

LG Docking Stations

Name	Supported from IGEL OS Version	Notes
LG USB Multi Port Hub	12.2.1	<p>Wake-on-LAN is supported from OS version 12.4.2 and with suspend mode only. Tested with:</p> <ul style="list-style-type: none"> • gram 14ZT90R • gram 15ZT90R • gram 17ZT90R

LG USB-C to Ethernet Adapter

Name	Supported from IGEL OS Version	Supported with	Notes
USB-C to Ethernet Adapter	12.4.2	<ul style="list-style-type: none"> gram 14ZT90 R gram 15ZT90 R gram 17ZT90 R 	Wake-on-LAN is supported from OS version 12.4.2 and with suspend mode only.

Pepperl+Fuchs

Na me	Device Category	Minimum Memory (RAM) Size	Storage Size	Processo r	Supported from IGEL OS Version	Name Displayed in IGEL System
BTC 22	Industrial Box Thin Client	8 GB	64 GB	Intel Atom x6413E	12.6.1	Pepperl+Fuchs BTC22
BTC 24	Industrial Box Thin Client	8 GB	64 GB	AMD Ryzen R2314	12.6.1	Pepperl+Fuchs BTC24

secunet

Name	Device Category	Supported from IGEL OS Version	Name Displayed in IGEL System
SinaWorkstation S P14s	Laptop/ Notebook	12.5.1	SINA Workstation S
SinaWorkstation S L590	Laptop/ Notebook	12.5.1	SINA Workstation S

Peripherals Supported by IGEL OS 12



 For the list of peripherals supported for IGEL OS 12, see also the IGEL Ready Showcase at <https://www.igel.com/ready/showcase-categories/peripherals-and-others/>.

- [Poly Headsets Supported by IGEL OS 12 \(see page 37\)](#)
- [Olympus and OM SYSTEM Devices Supported by IGEL OS 12 \(see page 39\)](#)

Poly Headsets Supported by IGEL OS 12

 A dongle must be used if delivered with a device (e.g. with a headset, etc.).

IGEL OS 12 supports the following Poly (former Polycom/Plantronics) headsets; the headsets have been tested with Microsoft Teams in a Citrix session.

Device	Microsoft Teams Certified ⁷	Notes	Verified with
Poly Encorepro 320			
Poly EncorePro 310 Monaural USB-A Headset			IGEL OS 12.06 and HP mt645 G8 and t655
Poly Voyager 4320			IGEL OS 12.06 and HP mt645 G8 and t655
Poly Voyager Focus 2		It is a known issue that the MS Teams button has no function.	IGEL OS 12.06 and HP mt645 G8 and t655
Poly Voyager Free 60+ UC M Carbon Black			IGEL OS 12.06 and HP mt645 G8 and t655
Poly Blackwire 5220 Stereo USB-C Headset			IGEL OS 12.06 and HP mt645 G8 and t655
Poly Blackwire 3320 Stereo			IGEL OS 12.06 and HP mt645 G8 and t655

7. <https://learn.microsoft.com/en-us/microsoftteams/devices/usb-devices?tabs=usb>

Device	Microsoft Teams Certified	Notes	Verified with
Poly Blackwire 3220 Stereo USB-C Headset			IGEL OS 12.06 and HP mt645 G8 and t655
Poly Savi 8220-M Stereo D2 Headset			IGEL OS 12.06 and HP mt645 G8 and t655
Poly Savi 8420 Stereo -M D2 Headset			IGEL OS 12.06 and HP mt645 G8 and t655
Poly Savi 8220 -M D2 USB-A Headset			IGEL OS 12.06 and HP mt645 G8 and t655
Poly EP 520 Bin Headset +QD, incl. Poly DA85-M USB to QD Adapter		The adapter allows the EP520 (and other Poly quick disconnect headsets) to connect to a USB port on the computer	IGEL OS 12.06 and HP mt645 G8 and t655
Poly DA85-M USB to QD Adapter		The adapter allows the EP520 (and other Poly quick disconnect headsets) to connect to a USB port on the computer	IGEL OS 12.06 and HP mt645 G8 and t655

Known Limitation of Citrix Workspace App

The answering and ending of calls through the HID buttons are not supported for any headsets.

Olympus and OM SYSTEM Devices Supported by IGEL OS 12

 To use Olympus / OM SYSTEM dictation devices, you have to install [Olympus virtual channel⁸](#) app.

The following devices are supported with Citrix Workspace app:

Olympus

Hand and Foot Switches

- RS27
- RS27H
- RS28
- RS28H
- RS31
- RS31H
- RS32

Dictation Devices

- DS9000
- DS9500

Dictation Microphones

- RM4000P
- RM4010P
- RM4015P
- RM4100S
- RM4110S

OM SYSTEM (Formerly Olympus Audio)

Hand and Foot Switches

- RS27N
- RS28N
- RS31N

Dictation Devices

- DS9100

8. <https://app.igel.com/olympus/4.0.5+1>

Supported Devices



Dictation Microphones

- RM4010N
- RM4110N

Limited Device Support for Legacy Devices and Special Use Cases with IGEL OS 12

IGEL offers Limited Device Support for legacy devices equipped with minimum 2 GB RAM and 64-bit-capable Dual Core CPU (or more) with a minimum of 1 GHz, and IGEL OS version 12.4.2 or later.

Limited Device Support is available for:

- Use cases utilizing only Virtual Apps/Virtual Desktop clients including Citrix Virtual Apps and Desktops, Omnissa Horizon, Microsoft AVD, Microsoft Remote Desktop (RDS), provided that the software's minimum hardware requirements are met.
- The use of Terminal Emulation client-side applications in IGEL OS 12
- Simple Digital Signage Use cases

Support Requirements

IGEL offers the the following support types for devices that meet the listed minimum requirements.

	CPU Cores	CPU Clock Speed (GHz)	Memory (GB)	Storage (GB)
Supported	≥ 2	≥ 1.5	≥ 4	≥ 8
Limited Device Support	≥ 2	1 - 1.49	2 - 3.9	≥ 8
Unsupported	1	< 1.0	< 2	< 8



All requirements must be met for a device to be considered either limited or fully supported. (i.e. If a device has 2 CPU Cores, 3 GB Memory, and 8 GB storage, but has a 1.5GHz CPU, the device has Limited Device Support.)

Please also keep in mind that this is for IGEL OS Base System only. 3rd Party applications may have higher requirements that need to be met to be fully supported.

Specific Use Cases Not Supported with Limited Device Support

Limited Device Support is not available for any other use cases, including the following:

- Any use case which leverages client-side rendering, for example:
 - Microsoft Teams Virtual Desktop / app optimization (where audio/video is rendered locally on the client)
 - Technologies such as Citrix HDX 3D-PRO or a similar technology that leverages client-side GPU
 - Virtual Desktop / apps browser content redirection (where browser content is rendered locally on the client)
 - Unified Collaboration / multimedia content or redirection for Virtual Desktops / apps
- The use of a local browser on IGEL OS 12, for example, Chromium, Firefox, Microsoft Edge
- The use of Unified Communication apps, for example, Microsoft Teams Progressive Web App, Zoom client locally on IGEL OS 12.



Please Note

It may still be possible to deploy local applications to IGEL OS 12 from the IGEL App Portal to a device covered by Limited Device Support, however, this may lead to system instability.

- Running multiple applications in parallel, for example, a Citrix virtual app and a desktop client at the same time as a Microsoft AVD client
- Any application where the vendor's minimum memory/CPU requirements are not met by the device hardware specification. Please refer to your specific vendor for more information.

The list above is non-exhaustive and only provides an overview of common, excluded use cases.

i Non-limited IGEL OS 12 support is only granted for devices that fulfill the minimal hardware requirements. Please see [Devices Supported by IGEL OS 12 \(see page 5\)](#) for reference and a list of officially supported and validated endpoints.

Limited Device Support is provided at IGEL's sole discretion and on a commercially reasonable endeavors basis. It is recommended to replace devices that do not meet the hardware requirements for IGEL OS 12 to receive full support and benefit from all current and planned features. IGEL will not consider the performance of Limited Support Devices in future versions of IGEL OS Base System or applications. Therefore, Customers' relying on Limited Device Support should test desired features and general usability before deploying base system or app updates. The performance of client or remote applications on legacy devices cannot be guaranteed and is provided on a commercially reasonable endeavors basis.

Resource consumption of partner applications (i.e. Citrix Workspace App, Omnisia Horizon Client) can grow over time. IGEL is not responsible for these changes and therefore customers need to reevaluate with every update of these partner apps whether their use cases are still viable.

For the avoidance of doubt, the initial requirement for Limited Device Support is only valid for devices with a 2 GB RAM and 64-bit-capable Dual Core CPU (or more) with a minimum of 1 GHz. IGEL requirements for hard drive/Flash specifications must be met.

Validated Devices for Limited Device Support

Dell / Wyse

Name	Device Category	Minimum Memory (RAM) Size	Storage Size	Processor	Notes
3040	Thin Client	2 GB	8 GB	Intel Atom x5-Z8350	No support for SSE4.1 which is required for <ul style="list-style-type: none"> • AVD • RDP • RD Web Access • IGEL Windows 365



IGEL OS 11 Hardware Support

- [Devices Supported by IGEL OS 11 \(see page 44\)](#)
- [IGEL Devices Supported by IGEL OS 11 \(see page 60\)](#)

Devices Supported by IGEL OS 11

In this article you can find the general hardware requirements for OS 11 and a list of devices that are tested by IGEL. For a list of IGEL devices that are not supported any more, see <https://kb.igel.com/knowledge-base-archive/current/>.



Partner Solutions for Peripheral Devices

For further supported hardware from IGEL partners, e.g. headsets, see [Partner Solutions](#)⁹.

Core Requirements

- CPU with 64-bit support
- CPU speed: ≥ 1 GHz
- Memory (RAM): ≥ 2 GB



RAM size higher than 2 GB is recommended if you use any of the following:

- Unified Communications optimizations (uses a client-side media engine)
- High-resolution graphics output
- More than two monitors



With devices that have 2 GB RAM and shared video memory, a maximum of 512 MB may be used as video memory.

- Storage: Depends on the release version of IGEL OS 11. The details are listed below:
 - Up to IGEL OS 11.03: 2 GB minimum; ≥ 4 GB recommended
 - From IGEL OS 11.04 to IGEL OS 11.07: If the full feature set is applied, at least 2.4 GB of storage is required. For instructions on how to reduce the feature set, see [Error: "Not enough space on local drive" when Updating to IGEL OS 11.08 or Higher](#)¹⁰.
 - From IGEL OS 11.08 onwards: If the full feature set is applied, at least 4 GB of storage is required. For instructions on how to reduce the feature set, see [Error: "Not enough space on local drive" when Updating to IGEL OS 11.08 or Higher](#)¹¹.
- No VIA graphic adapter; VIA graphics support is discontinued in IGEL OS.
- Legacy Bios and EFI/UEFI are supported.

9. <https://kb.igel.com/en/igel-os/current/partner-solutions>

10. <https://kb.igel.com/en/igel-os/current/error-not-enough-space-on-local-drive-when-updatin>

11. <https://kb.igel.com/en/igel-os/current/error-not-enough-space-on-local-drive-when-updatin>

Devices Supported by OSC and UD Pocket with IGEL OS 11

 The following list only includes those devices that are **tested by IGEL** (with each major release of IGEL OS). By no means it implies that the devices which are not included in this list but meet the minimum requirements will not function with IGEL OS: Any x86-64 hardware endpoint device that meets the IGEL-stated minimum hardware requirements for IGEL OS (for example, the processor speed and RAM) can be expected to work adequately with IGEL OS and should be considered a candidate for repurposing from another OS. With an IGEL OS subscription or active maintenance, customers can expect IGEL to make any necessary “best effort” to support, regardless of whether the endpoints in question are specifically listed within the IGEL Knowledge Base or elsewhere (e.g. on the IGEL Ready Showcase at <https://www.igel.com/ready/showcase-categories/endpoints/>).

For any devices not listed here or on the IGEL Ready showcase, you can contact your hardware vendor and request those devices to be added to the IGEL Ready program.

Integrated drivers and supported peripherals are listed in the [Third-Party Hardware Database](#)¹². For more solutions compatible with IGEL OS, see [Partner Solutions](#)¹³.

 HP, Lenovo, and LG device models are available from the factory with pre-installed IGEL OS 11. Please contact [IGEL Ready](#)¹⁴ to get information on which device models are available with pre-installed IGEL OS.

 For some of the devices listed here, Flash memory must be extended to ≥ 2 GB. For these devices, an appropriate note is added.

 On modern computers such as secured-core PCs (see e.g. <https://www.microsoft.com/en-us/windows/business/devices?col=secured-core-pcs>), there may be a BIOS setting related to Secure Boot that allows the use of Microsoft’s 3rd party UEFI Secure Boot Certificate. The usual description of such a BIOS setting is "Allow Microsoft 3rd Party UEFI CA". This setting must be set to enabled, as IGEL uses the 3rd party certificate to support UEFI Secure Boot. If UEFI Secure Boot is enabled, but "Allow Microsoft 3rd Party UEFI CA" is not enabled, you may be unable to boot IGEL OS Creator or UD Pocket. Similarly, if the setting "Allow Microsoft 3rd Party UEFI CA" is disabled after a previous installation of IGEL OS, IGEL OS will fail to boot. For how to enable the setting, see [Secured-Core PCs: Microsoft 3rd-Party UEFI Certificate for Secure Boot](#)¹⁵.

 [Fn] keys may not work on some supported and listed laptop/notebook models.

12. <https://www.igel.com/linux-3rd-party-hardware-database/>

13. <https://kb.igel.com/en/igel-os/current/partner-solutions>

14. <https://www.igel.com/technology-partners/>

15. <https://kb.igel.com/en/security-safety/current/secured-core-pcs-microsoft-3rd-party-uefi-certific>

ADS-Tec

Name	Device Category	Minimum Memory (RAM) Size	Storage Size	Processor	Supported from IGEL OS Version
DVG-VMT9010	Industrial PC/ Terminal	4 GB 8 GB	64 GB eMMC	Intel Atom® x7-E3950	11.02.100
DVG-VMT9012	Industrial PC/ Terminal	4 GB 8 GB	64 GB eMMC	Intel Atom® x7-E3950	11.02.100
DVG-VMT9015	Industrial PC/ Terminal	4 GB 8 GB	64 GB eMMC	Intel Atom® x7-E3950	11.02.100
DVG-VMT9112	Industrial PC/ Terminal	4 GB 8 GB	64 GB eMMC	Intel Atom® x7-E3950	11.02.100

Advantech

Name	Device Category	Minimum Memory (RAM) Size	Storage Size	Processor	Supported from IGEL OS Version
POC-W213L	Medical All in One	4 GB	128 GB	Intel Core i7-7300U	11.01.100
POC-W243L*	Medical All in One	4 GB	32 GB	Intel Kaby Lake Core i5-7300U	11.01.110
POC-W243L* (see page 44)	Medical All in One	4 GB	128 GB	Intel Core i7-7300U	11.01.100

Advantech-DLoG

Name	Device Category	Minimum Memory (RAM) Size	Storage Size	Processor	Supported from IGEL OS Version
DLT-V6210	Industrial PC/ Terminal	4 GB	32 GB	Intel Atom	11.01.100

Name	Device Category	Minimum Memory (RAM) Size	Storage Size	Processor	Supported from IGEL OS Version
DLT-V7210 K	Industrial PC/ Terminal	4 GB	4 GB	Intel Atom E3845	11.01.100

Dell / Wyse

Name	Device Category	Minimum Memory (RAM) Size	Storage Size	Processor	Supported from IGEL OS Version	Notes
5040 / 5212	All in One	2 GB	2 GB	AMD G-T48E	11.01.100	
3040	Thin Client	2 GB	8 GB	Intel Atom x5-Z8350	11.01.100	
5020	Thin Client	2 GB	8 GB	AMD G-Series SoC	11.02.140	
5060	Thin Client	4 GB	8 GB	AMD GX-424CC	11.01.100	
5070	Thin Client	8 GB	32 GB	Intel Celeron J4105	11.01.100	
Latitude 5510	Laptop/ Notebook	8 GB	256 GB	Intel Core i5-10210U	11.05.100	Wake-on-LAN functionality is not supported.
Optiplex 3000	Thin Client	4 GB	32 GB	Intel Celeron N5105	11.08.200	

Dynabook

Name	Device Category	Minimum Memory (RAM) Size	Storage Size	Processor	Supported from IGEL OS Version
Portegé X20W-D	Laptop/ Notebook	8 GB	256 GB	Intel Core i5-7200U	11.01.100
Portegé X30-D	Laptop/ Notebook	8 GB	256 GB	Intel Core i5-7300U	11.01.100

Name	Device Category	Minimum Memory (RAM) Size	Storage Size	Processor	Supported from IGEL OS Version
Tecra C50	Laptop/ Notebook	4 GB	500 GB	Intel i5-4210U	11.01.100
Tecra Z50-D	Laptop/ Notebook	8 GB	256 GB	Intel Core i5-7200U	11.01.100
SATELLITE R50	Laptop/ Notebook	4 GB	500 GB	Intel i3-6006U	11.01.100

Elo

Name	Device Category	Minimum Memory (RAM) Size	Storage Size	Processor	Supported from IGEL OS Version
i2 Touch (15 and 22 inches)	All in One	8 GB	128 GB	Intel Core i3-8100T	11.05.100

Fujitsu

Name	Device Category	Minimum Memory (RAM) Size	Storage Size	Processor	Supported from IGEL OS Version
Q957	Desktop PC	8 GB	500 GB	Intel Core i3-6100	11.02.100
FUTRO S740	Thin Client	4 GB	8 GB	Intel Celeron J4105	11.04.100

HP

Name	Device Category	Minimum Memory (RAM) Size	Storage Size	Processor	Supported from IGEL OS Version	Wi-Fi Chip	Notes
HP t420	Thin Client	2 GB	8 GB	AMD Embedded G-Series GX-209JA	11.02.100		
HP t430	Thin Client	2 GB	16 GB	Intel®Celeron® N4020	11.01.110	Intel AC9260	
HP t530	Thin Client	4 GB	8 GB	AMD GX-215JJ Dual-Core	11.01.100		
HP t630	Thin Client	4 GB	8 GB	AMD GX-420GI	11.01.100		
HP t730	Thin Client	16 GB	8 GB	AMD RX-427BB APU	11.01.100		
HP t820	Thin Client	16 GB	16 GB	Intel Core i5-4570S	11.01.100		
HP t640	Thin Client	4 GB	16 GB	AMD Ryzen R1505G	11.04.100	Intel AC9260 Realtek RTL8852 AE	This model is not supported with HP USB-C Essential G5 Dock
HP t540	Thin Client	16 GB	16 GB	AMD Ryzen Embedded R1305G	11.06.100	Intel AC9260 Realtek RTL8852 AE	

Name	Device Category	Minimum Memory (RAM) Size	Storage Size	Processor	Supported from IGEL OS Version	Wi-Fi Chip	Notes
HP mt46	Mobile Thin Client	8 GB	32 GB	AMD Ryzen 3 PRO 4450U	11.07.100		Excluding support for WWAN and Wake-on-LAN (both features are planned)
HP Elite t655	Thin Client	4 GB / 8 GB	32 GB	AMD Ryzen Embedded R2314	11.07.160	Realtek RTL8852 BE	
HP Elite mt645 G7	Mobile Thin Client	8 GB	256 GB	AMD Ryzen 3 5425U	11.08.230	Realtek RTL8852 BE	Support for WWAN Intel XMM 7560 (as of 11.08.330) Excluding support for Wake-on-LAN (feature is planned) Excluding support for built-in fingerprint sensor
				AMD Ryzen 5 5625U	11.08.330		
HP t740	Thin Client	8 GB	16 GB	AMD Ryzen Embedded V1756B	11.08.290	Realtek RTL8852 AE	
HP Pro t550	Thin Client	4 GB	32 GB	Intel Celeron J6412	11.08.330	Realtek RTL8852 CE (Supported as of 11.09.150)	
HP Pro mt440 G3	Mobile Thin Client	8 GB	128 GB	Intel Celeron 7305	11.08.440	Realtek RTL8852 BE	Support for WWAN Intel XMM 7560 (as of 11.09.260)

Name	Device Category	Minimum Memory (RAM) Size	Storage Size	Processor	Supported from IGEL OS Version	Wi-Fi Chip	Notes
HP Elite t755	Thin Client	8 GB	128 GB	AMD Ryzen Embedded V2546	11.09.260	Realtek RTL8852 CE	<p>This model offers no USB-C docking support</p> <p>Starting from OS version 11.10.210, the model is supported with:</p> <ul style="list-style-type: none"> • Intel i226, 2.5Gbps Ethernet card • Allied Telesis 2914SP Gbps PCIe network adapter with SFP port for Ethernet/SFP/WoL
HP Elite mt645 G8	Mobile Thin Client	16 GB	256 GB	AMD Ryzen-5 7535U, Ryzen-3 7335U	11.10.150	<ul style="list-style-type: none"> • Realtek 8852CE • AMD RZ616 	<p>WWAN: HP 4000 4G LTE</p> <p>Touchscreen supported (tested model: ELAN2513:00)</p>

HP Docking Stations

Name	Supported from IGEL OS Version	Notes
HP USB-C Docking Station G5	11.08.230	
HP USB-C G5 Essential Dock	11.08.290	Not supported with HP t640

Intel

Name	Device Category	Minimum Memory (RAM) Size	Storage Size	Processor	Supported from IGEL OS Version
NUC 5i5MYHE	Desktop PC	2 GB	32 GB	Intel i5-5300U	11.01.100

Name	Device Category	Minimum Memory (RAM) Size	Storage Size	Processor	Supported from IGEL OS Version
NUC 5i3RYH	Desktop PC	2 GB	2 GB	Intel i3-5010U	11.01.100
NUC 7CJYH	Desktop PC	2 GB	4 GB	Intel Celeron J4005	11.01.100

Lenovo

Name	Device Category	Minimum Memory (RAM) Size	Storage Size	Processor	Wi-Fi Chip	Supported from IGEL OS Version	Notes
ThinkCentre M625q	Desktop PC	4 GB	32 GB	AMD E2-9000e	Intel AC9260	11.04.100	
		8 GB	128 GB	AMD A4-9120e	QCA6174 802.11ac	11.04.100	
ThinkCentre M75n	Desktop PC	8 GB	256 GB	AMD Ryzen 3 Pro 3300U	Intel AC9260	11.05.100	
ThinkCentre M70q Gen1	Desktop PC	16 GB	256 GB	Intel i5-10500t	Comet Lake PCH CNVi WiFi, Intel	11.05.100	
ThinkCentre M70q Gen 3	Desktop PC	16 GB	256 GB	Intel Core i5-12500T	Intel AX201	11.08.240	
ThinkCentre M75q Gen2	Desktop PC	4 GB	128 GB	AMD Ryzen 3 Pro 5350GE	Intel AX200	11.08.240	
K14 AMD Gen1	Laptop/ Notebook	8 GB	256 GB	AMD Ryzen 5 PRO 5650U	Mediatek MT7921	11.08.240	
ThinkPad L14 Gen1 AMD	Laptop/ Notebook	64 GB	1 TB	AMD Ryzen 7 Pro 4750U	Wi-Fi 6 AX200, Intel	11.05.100	

Name	Device Category	Minimum Memory (RAM) Size	Storage Size	Processor	Wi-Fi Chip	Supported from IGEL OS Version	Notes
14w	Laptop/ Notebook	4 GB	64 GB	AMD A6-9220C	QCA6174 802.11ac	11.05.100	
ThinkPad L14 Gen3 AMD	Laptop/ Notebook	16 GB	256 GB	AMD Ryzen 5 5625U	AMD RZ616 2X2AX (WiFi 6E)	11.08.230	WWAN: Quectel EM05-G 4G CAT4 LTE support as of 11.08.360
ThinkCentre Neo50q Gen4	Thin Client	8 GB	256 GB	Intel Core i3-1215U	Wi-Fi 6 RTL8852BE	11.08.240	
		4 GB	256 GB	Intel Celeron 7305	Wi-Fi 6 AX201		
K14 Gen1 Intel	Laptop/ Notebook	16 GB	256 GB	Intel Core i5-1135G7	Intel AX210 WiFi / BT combo	11.08.290	
ThinkPad L14 Gen3 Intel	Laptop/ Notebook	16 GB	512 GB	Intel Core i5-1235U	Intel Wi-Fi 6 AX201 2x2 AX vPro	11.08.330	WWAN: Quectel EM05-G 4G CAT4 LTE support as of 11.08.360
ThinkEdge SE10	Thin Client	8 GB	1 TB	Intel Atom x6425RE	MediaTek MT7921LEN	11.08.360	
			256 GB	Intel Atom x6214RE	Intel AX210	11.08.360	

Name	Device Category	Minimum Memory (RAM) Size	Storage Size	Processor	Wi-Fi Chip	Supported from IGEL OS Version	Notes
ThinkPad L14 Gen4 AMD	Laptop/ Notebook	8 GB	256 GB	AMD Ryzen 3 Pro 7330U	AMD RZ616 Realtek RTL8852CE	11.08.440	WWAN: Quectel EM05-G 4G CAT4
ThinkPad L15 Gen4 AMD	Laptop/ Notebook	8 GB	256 GB	AMD Ryzen 3 Pro 7330U	AMD RZ616 Realtek RTL8852CE	11.08.440	WWAN: Quectel EM05-G 4G CAT4
ThinkPad L14 Gen4 Intel	Laptop/ Notebook	8 GB	256 GB	Intel Core i3-1315U	Intel AX211	11.09.100	WWAN: Quectel EM05-G 4G CAT4
ThinkPad L15 Gen4 Intel	Laptop/ Notebook	8 GB	256 GB	Intel Core i3-1315U	Intel AX211	11.09.100	WWAN: Quectel EM05-G 4G CAT4
ThinkPad L13 Gen4 Intel	Laptop/ Notebook	8 GB	256 GB	Intel Core i3-1315U	Intel AX201	11.09.210	WWAN: Quectel EM05-G 4G CAT4 No integrated LAN
ThinkPad L13 Gen4 AMD	Laptop/ Notebook	16 GB	256 GB	AMD Ryzen 3 PRO 7330U	AMD RZ616	11.09.210	WWAN: Quectel EM05-G 4G CAT4 No integrated LAN

Name	Device Category	Minimum Memory (RAM) Size	Storage Size	Processor	Wi-Fi Chip	Supported from IGEL OS Version	Notes
ThinkPad L14 Gen5 Intel	Laptop/ Notebook	16 GB	256GB	Intel Core Ultra 5 135U	Intel AX211	11.10.150	WWAN: Quectel EM160R-GL Gen2, Quectel EM061K-GL

Lenovo Docking Stations

Name	Supported from IGEL OS Version
ThinkPad USB-C Hybrid Dock	11.07.100
IOBOX	11.07.100
Universal USB-C Dock	11.08.440

Lenovo USB-C to Ethernet Adapter

Name	Supported from IGEL OS Version	Supported with	Notes
USB-C to Ethernet Adapter	11.09.260	<ul style="list-style-type: none"> ThinkPad L13 Gen4 Intel/AMD ThinkPad L14 Gen4 AMD 	<p>Wake-on-LAN is supported from OS version 11.10.210 and with suspend mode only.</p> <p>Tested with:</p> <ul style="list-style-type: none"> ThinkPad L13 Gen4 AMD

LG

Name	Device Category	Minimum Memory (RAM) Size	Storage Size	Processor	Supported from IGEL OS Version
24CK550**	All in One	4 GB	32 GB	AMD G-Series GX-212JJ	11.01.100
24CK560** (see page 44)	All in One	4 GB	32 GB	AMD G-Series GX-212JJ	11.01.100

Name	Device Category	Minimum Memory (RAM) Size	Storage Size	Processor	Supported from IGEL OS Version
CK500	Thin Client	4 GB	32 GB	AMD G-Series GX-212JJ	11.01.100
38CK950	All in One	8 GB	128 GB	AMD Ryzen 3	11.02.100
38CK900	All in One	8 GB	128 GB	AMD Ryzen 3	11.02.100
CL600	Thin Client	4 GB	16 GB	Intel® Celeron J4105	11.03.100
CL600	Thin Client	8 GB	128 GB	Intel® Celeron J4105	11.03.100
34CN650	All in One	4 GB	16 GB	Intel® Celeron J4105	11.05.100
24CN650	All in One	8 GB	16 GB	Intel® Celeron J4105	11.05.100
27CN650	All in One	8 GB	16 GB	Intel® Celeron J4105	11.05.100
CQ600	Thin Client	4 GB	16 GB	Intel Celeron N5105	11.08.330
24CQ650	All in One	4 GB	16 GB	Intel Celeron N5105	11.08.330
CQ601	Thin Client	4 GB	16 GB	Intel Pentium Silver N6005	11.08.360
24CR670	All in One	4 GB	16 GB	Intel Celeron N5105	11.09.110
34CR650	All in One	4GB	16 GB	Intel Celeron N5105	11.09.210
27CQ650	All in One	4GB	16 GB	Intel Celeron N5105	11.09.210

LG Docking Stations

Name	Supported from IGEL OS Version
LG USB Multi Port Hub	11.09.100

LG USB-C to Ethernet Adapter

Name	Supported from IGEL OS Version	Notes
USB-C to Ethernet Adapter	11.10.210	Wake-on-LAN is supported from OS version 11.10.210 and with suspend mode only.

OnLogic

Name	Device Category	Minimum Memory (RAM) Size	Storage Size	Processor	Supported from IGEL OS Version
CL210G-10	Industrial PC/ Terminal	4 GB	32 GB	Intel Celeron N3350	11.04.100
KARBO N 300	Desktop PC	4 GB	32 GB	Intel Atom x5-E3930	11.04.100

Onyx Healthcare

Name	Device Category	Minimum Memory (RAM) Size	Storage Size	Processor	Supported from IGEL OS Version
Venus 223	Medical All in One	4 GB	128 GB	Intel Quad-Core J1900	11.01.100

Pepperl+Fuchs

Name	Device Category	Minimum Memory (RAM) Size	Storage Size	Processor	Supported from IGEL OS Version
BTC1 2N	Industrial Box Thin Client	4 GB	32 GB	Intel Apollo Lake N4200	11.09.100
BTC1 4N	Industrial Box Thin Client	4 GB	32 GB	AMD Ryzen Embedded V1202B	11.09.100

Rein Medical

Name	Device Category	Minimum Memory (RAM) Size	Storage Size	Processor	Supported from IGEL OS Version
Silenio C122	All in One	8 GB	128 GB	Intel® Core™ i5 – 6th Generation	11.01.110
Silenio C124	All in One	8 GB	128 GB	Intel® Core™ i5 – 6th Generation	11.01.110
Clinio S 522TCT	Medical All in One	8 GB	16 GB	Intel® Pentium® Silver J5005	11.04.100
Clinio S 524TCT	Medical All in One	8 GB	16 GB	Intel® Pentium® Silver J5005	11.04.100

Secunet

Name	Device Category	Minimum Memory (RAM) Size	Storage Size	Processor	Supported from IGEL OS Version
SINA Workstation S EliteDesk 800 G2	Workstation	16 GB	256 GB	Intel Core i7-6700	11.01.100

USB Memory Sticks That Can Be Used as UD Pocket Hardware

DIGITTRADE

Name	Storage	Supported from IGEL OS Version
Kobra Stick	≥ 4GB	11.05.133

Transcend

Name
UD Pocket¹⁶
IGEL UD Pocket 2¹⁷

16. <https://kb.igel.com/en/igel-os/current/ud-pocket>

17. <https://kb.igel.com/en/hardware/current/ud-pocket-2>

Officially Supported Virtual Environments

- Tested with Ubuntu (64-bit) and default settings

 Note that the use of a UD Pocket within a virtual machine is **not** supported by IGEL.

 For some features, more than 2 GB RAM is required. Example: if you use dual monitor environments, a virtual machine must have at least 8 GB RAM.

Name	Memory (RAM)	Storage	Type	Supported from IGEL OS Version
Oracle VM VirtualBox	≥ 2 GB	≥ 4 GB	Linux	11.04.100
VMware Workstation	≥ 2 GB	≥ 4 GB	Linux	11.04.100

* Delock Adapter DP 1.2 to DVI does not work.

** When using an additional 4k screen with this device, please edit the BIOS settings as follows:

1. Go to the **Chipset** screen.
2. Set **Integrated Graphics** to “Force”.
3. Set **UMA Frame Buffer Size** to “256M” or higher

IGEL Devices Supported by IGEL OS 11

Core Requirements for IGEL OS 11

- CPU with 64-bit support
- CPU speed: ≥ 1 GHz
- Memory (RAM): ≥ 2 GB

- i** RAM size higher than 2 GB is recommended if you use any of the following:
- Unified Communications optimizations (uses a client-side media engine)
 - High-resolution graphics output
For details on the supported graphics-related characteristics of IGEL devices, see <https://kb.igel.com/hardware/current/graphics-on-igel-devices>.
 - More than two monitors

- Storage: 2 GB minimum; ≥ 4 GB recommended

- i** Storage Requirements for IGEL OS 11.04 or Higher
- IGEL OS 11.04.100 or higher requires at least 2.4 GB storage if the full feature set is applied. Thus, the feature set must be modified accordingly; for more information, see (11.10.190-en) Error: "Not enough space on local drive" when Updating to IGEL OS 11.08 or Higher .

IGEL Devices Supported by IGEL OS 11

IGEL UD (Universal Desktop)

You can find a list of IGEL devices delivered with IGEL OS 11 that already reached their end of maintenance under <https://kb.igel.com/knowledge-base-archive/current/archive-list-of-legacy-igel-devices>.

Product Line	Device Type	Hardware ID	64 Bit	Memory (RAM)	Storage	HW Video Acceleration	
UD2	M250C	51 / 52	Yes	2 or 4 GB	8 GB	Yes	IGEL UD2-LX 52 is supported with IGEL OS 11.06.140 and later.
UD3	M350C	60	Yes	4 GB	8 GB	Yes	
UD7	H860C	20	Yes	8 GB	8 GB	Yes	

Details on IGEL UD Devices can be found under <https://kb.igel.com/knowledge-base-archive/current/eol-eos-eom-archive>.

IGEL Zero



Note on IZ Devices

The IZ devices listed below can be upgraded to IGEL OS 11. To upgrade your IZ devices to IGEL OS 11, please contact your IGEL sales representative. See also <https://www.igel.com/os11migration/>.

Product Line	Device Type	Hardware ID	64 Bit	Memory (RAM)	Storage	UEFI Secure Boot Support	HW Video Acceleration
IZ2	D220	40	Yes	2 GB	4 GB	Yes	Yes
IZ3	M340C	50	Yes	2 GB	4 GB	Yes	Yes
IZ3	M340C	51	Yes	2 GB	4 GB	Yes	Yes

IGEL UD Pocket

The IGEL UD Pocket is a dedicated USB device that boots IGEL OS on a host computer without modifying the existing operating system on the device's internal storage. It serves as the hardware foundation for the USB Boot option of the IGEL Business Continuity & Disaster Recovery (BC&DR) solution. For details, see <https://www.igel.com/business-continuity-disaster-recovery/>.

- [Information](#) (see page 63)
- [Technical Specification of UD Pocket 2](#) (see page 64)
- [Regulatory Compliance Information](#) (see page 66)

Information

Copyright – Copyright Publishing. All Rights Reserved

This manual is protected under Copyright Law. All rights are exclusively reserved by IGEL Technology. This manual or any part of it may not be copied, reproduced, transmitted, altered, transcribed, stored in a retrieval system, or translated into any language, without the express written consent of IGEL Technology GmbH.

Copyright © 06/2021 IGEL Technology GmbH

Disclaimer

This manual and the information contained herein only serve for information purposes. IGEL Technology GmbH reserves the right to modify, delete or alter any data and information contained herein.

The latest version of this document is provided online under <https://kb.igel.com/hardware/current/>.

IGEL Technology GmbH is not liable and does not guarantee the correctness and completeness of the information contained in this document, including product and software description.

IGEL is a registered trademark of IGEL Technology GmbH. All hardware and software names are registered trademarks of the respective manufacturers. Errors and omissions excepted. Subject to change without notice.

IGEL Technology GmbH
Maria-Cunitz-Str. 7
28199 Bremen
Germany
Phone: +49 421 52094 0
Fax: +49 421 52094 1499
E-Mail: info@igel.com¹⁸

18. <mailto:info@igel.com>

Technical Specification of UD Pocket 2



Requirements for the Endpoint

See [Devices Supported by IGEL OS 12 \(see page 5\)](#) and [Devices Supported by IGEL OS 11 \(see page 44\)](#)

System

Operating system	IGEL OS 12 or IGEL OS 11
Management	Universal Management Suite (UMS)
Memory	32 GB (physical capacity; data storing not possible)

Interface



- USB Type-C
- USB 3.0 Gen 1 Type-A (backward compatible with USB 2.0)

Dimensions and Weight

Device (DxWxH), vertical	8.6 x 14.3 x 28.6 mm
Device weight	3 g
Packaging (DxWxH), horizontal	50 x 75 x 15 mm

Operating Conditions

Operating temperature	0 °C – 70 °C, 32 °F – 158 °F
Operating humidity	0 % – 95 %

Hardware Warranty

The device comes with a standard two-year warranty, starting from the date of delivery.

You can extend the warranty to 3 years, by taking advantage of our free online registration.

Regulatory Compliance Information

FCC Compliance Statement

This equipment has been tested and found to comply with the limits for a Class B digital device, pursuant to Part 15 of the FCC rules. These limits are designed to provide reasonable protection against harmful interference in a residential installation. This equipment generates, uses and can radiate radio frequency energy and if not installed and used in accordance with the instructions, may cause harmful interference to radio communications. However, there is no guarantee that interference will not occur in a particular installation. If this equipment does cause harmful interference to radio or television reception, which can be determined by turning the equipment off and on, the user is encouraged to try to correct the interference by one or more of the following measures:

- Reorient or relocate the receiving antenna.
- Increase the separation between the equipment and receiver.
- Connect the equipment into an outlet on a circuit different from that to which the receiver is connected.
- Consult the dealer or an experienced radio/TV technician for help.

Shielded interface cables must be used in order to comply with emission limits.

Changes or modifications not expressly approved by the party responsible for compliance could void the user's authority to operate the equipment.

WEEE Note

In accordance with EU directive 2012/19/EU on Waste Electrical and Electronic Equipment (WEEE), customers and manufacturers are responsible for returning and recycling their old equipment and batteries. IGEL now offers a convenient free Collection Service. The Customer is obliged to delete personal and business data on the devices before using this Collection Service.

To request a collection of the old IGEL units, fill out the RMA form on <https://support.igel.com/csm>. An IGEL service employee will contact you then to arrange a collection date.

IGEL WEEE number: DE 79295479

Hardware How-Tos

- [Attaching Rubber Feet to UD Housing](#) (see page 68)
- [COM Port Power Supply on M350C and H860C Devices](#) (see page 70)
- [UD3 Model M350C: Multistream Transport](#) (see page 72)
- [UD7 Model H860C: Multistream Transport \(MST\) / Monitor Daisy Chaining](#) (see page 78)
- [VESA Mount for M250C, M350C, and H860C](#) (see page 83)

Attaching Rubber Feet to UD Housing

i The following instructions are valid for UD2, UD3, UD5/6, and UD7. The schematic illustrations are provided for the previous IGEL design ID (based on the UD3) and for the newest IGEL design ID (based on the UD2). The relevant properties, e.g. the relative positions of the power button, are the same for all housings.

You can use IGEL UD2, UD3, UD5/6, and UD7 devices in a horizontal position. For this purpose, you must attach rubber feet to the housing.

x For safe operation, use only the rubber feet provided by IGEL Technology GmbH.

The following description shows you how to mount the rubber feet on the device's housing.

1. Tilt the housing to the left so that the power button is on the left-hand side.

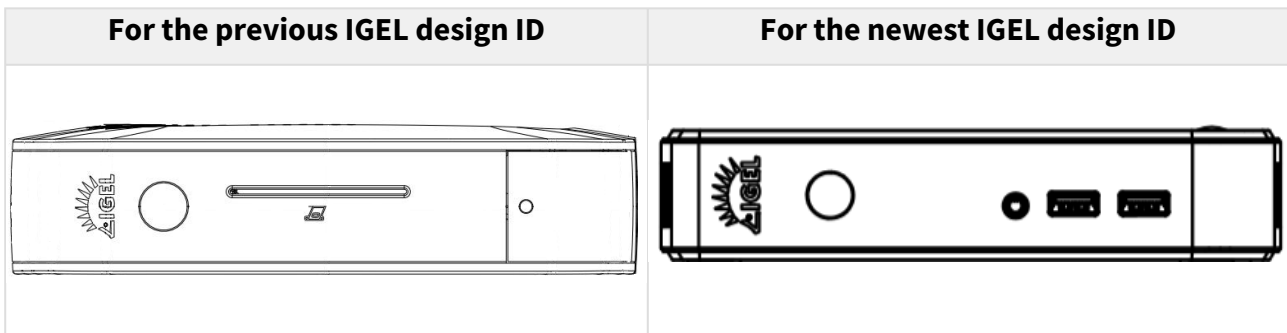

2. Remove the rubber feet from their protective foil.
3. Stick the feet on the bottom part of the housing near the border of the ventilation slots area.

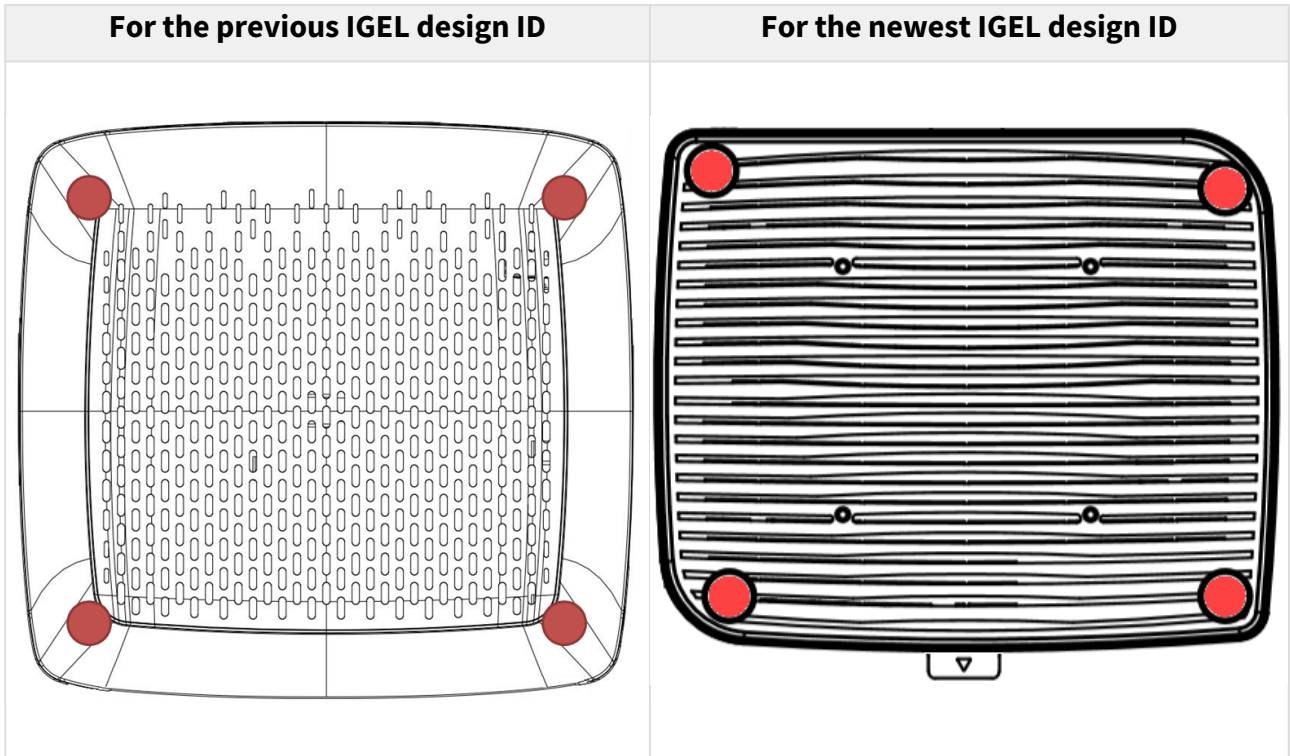

4. Put the housing on its feet as shown below.

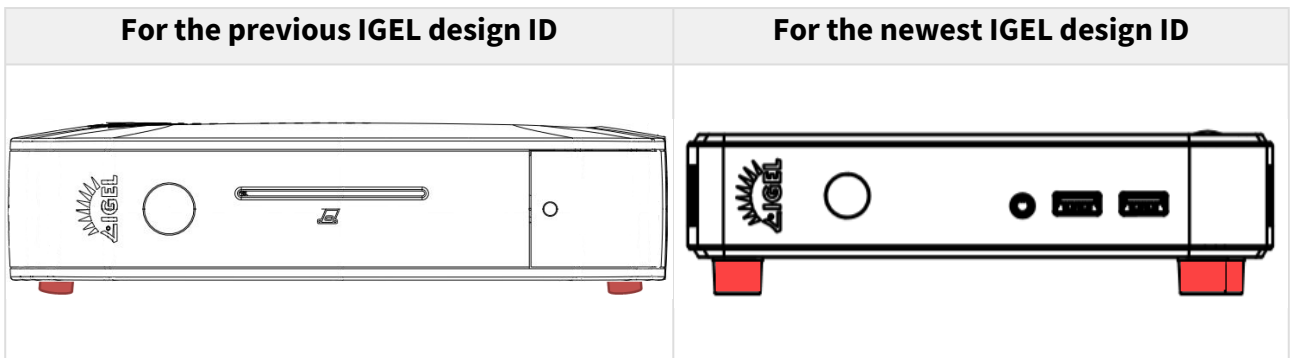

 Make sure that the upper ventilation slots are not covered!

COM Port Power Supply on M350C and H860C Devices

If you connect devices to your UD3 model M350C or UD7 model H860C that require a serial (COM) port and a power supply of 5 V, you can activate the corresponding option in BIOS to spare the usage of an additional power supply unit.

To enable the 5 V power supply option for the COM port, proceed as follows:

1. Turn on or restart the IGEL device.
2. During boot, hold the [DEL] key until you see the **Front Page** menu.

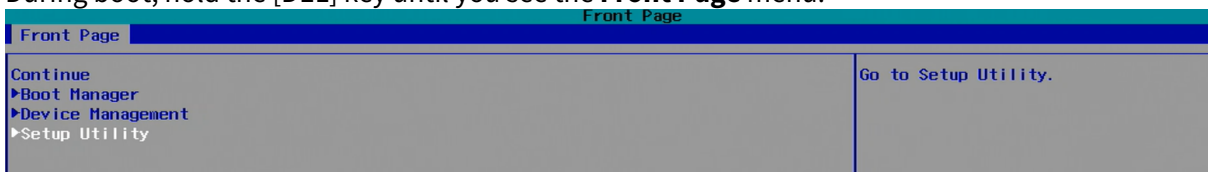

3. Using the arrow keys, navigate to the option **Setup Utility** and press [ENTER]. The **InsydeH20 Setup Utility** opens.
4. Using the arrow keys, move to the tab **Power**. You will find **COM Port Power Supply** set to **<Disabled>**.

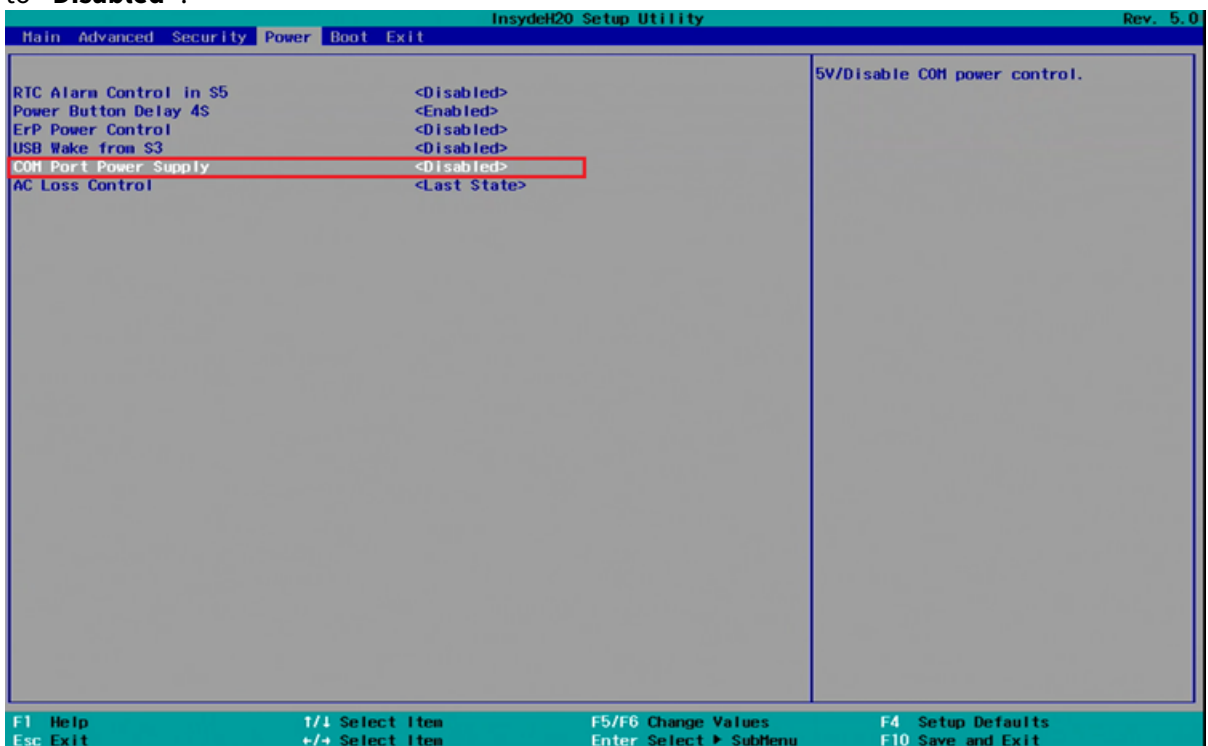

5. Change **COM Port Power Supply** to **<5V>** and press [ENTER].

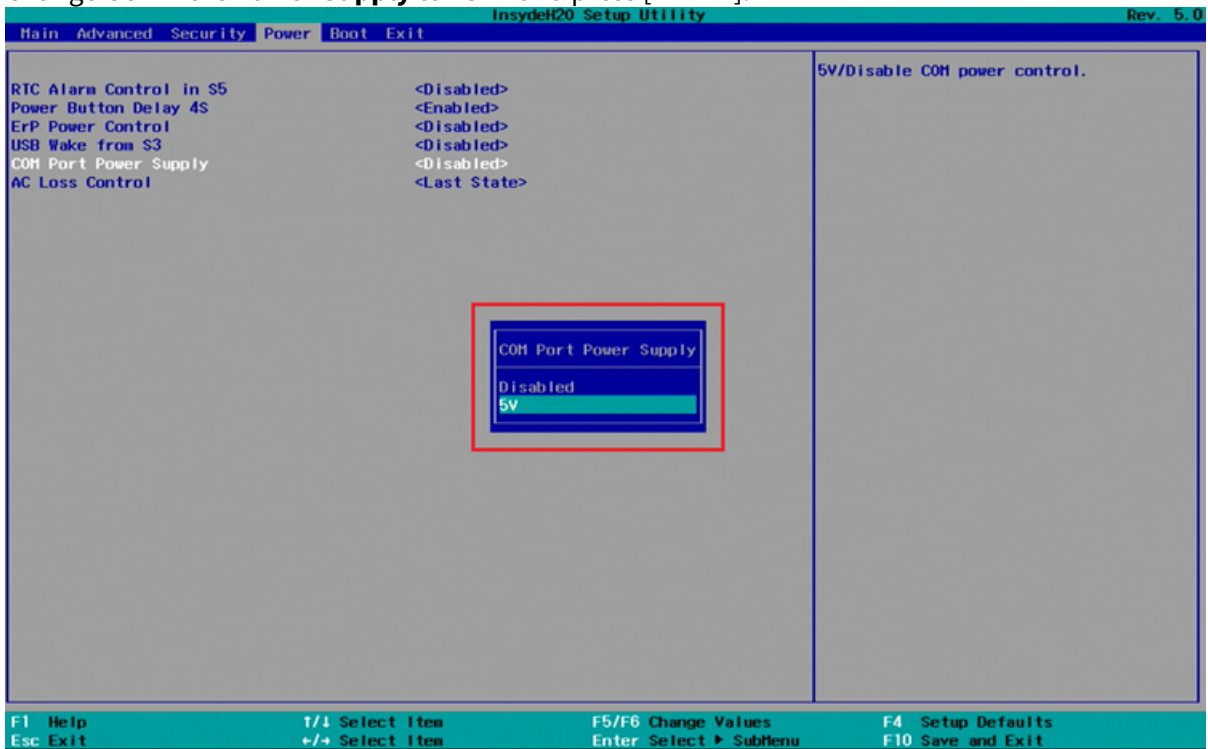

6. Press [F10] to save the changes and exit.

i This option is NOT suitable for devices with a serial (COM) port that require a 12 V power supply.

UD3 Model M350C: Multistream Transport

This how-to explains how to configure multistream transport (MST) on an M350C device.

Prerequisites

- IGEL UD3 model M350C
- IGEL OS 11.03.100 and higher
- DisplayPort multistream transport hub (DP MST hub) with 2x DisplayPort 1.2.

 For the testing, [LINDY 2 Port DP Expander Splitter / MST Hub¹⁹](#) was used.

 **Max. Supported Resolution when Using a DP MST Hub**
The max. total resolution of the monitors connected via a DP MST hub cannot exceed 4K, see [Graphics on IGEL Devices \(see page 98\)](#).

Thus, the max. supported resolution on an M350C device is:

- max. 1x 4K on the first DP port
and
- max. 4K divided between the monitors connected to the second DP port of the M350C device via the DP MST hub

Connecting Monitors

This is how you can connect three monitors to your M350C device - one monitor to the first DP port on the device and the other two monitors with a DP MST hub to the device's second DP port:

1. Connect one monitor to the first DP port on your device.

19. <https://www.lindy-international.com/DisplayPort-1-2a-Splitter-2-Port.htm?websale8=ld0101.ld020102&pi=38402&ci=20>

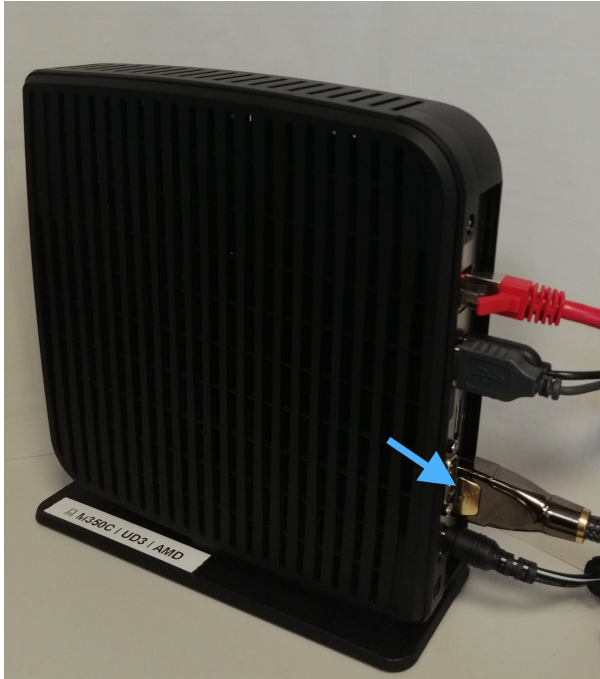

2. Connect the other two monitors to the **Out 1** and **Out 2** outputs on the DP MST hub.



3. Connect the DP MST hub to the other DP port on the device.

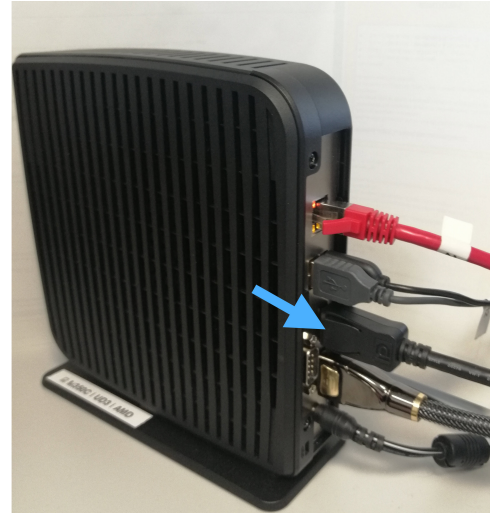
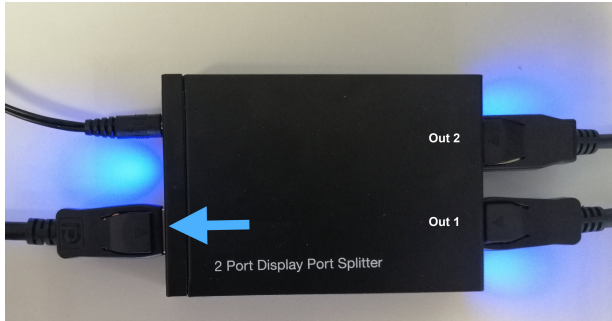

i It is irrelevant which DP port on your M350C device will be chosen for the connection of the DP MST hub.

✓ If hotplug was not successful, disconnect the DP MST hub from the device and connect it again.

Now it is necessary to configure the connected monitors. You have two options:

- Automatic screen configuration. In this case, the firmware recognizes and applies the screens automatically by default. See also *IGEL OS > IGEL OS Articles > Desktop and Display > Multimonitor > Automatic Configuration*
- Manual screen configuration. If the automatic configuration does not suit your needs, you can also configure screens manually. See also *IGEL OS > IGEL OS Articles > Desktop and Display > Multimonitor > Manual Configuration*

i It is strongly recommended to use the automatic screen configuration.

Automatic Configuration

1. In IGEL Setup, go to **User Interface > Display**.
2. Under **Number of screens**, select **3**.

i If **Number of screens** is set to "1", the same content will be displayed on all three monitors.

3. Choose the screen under **Selected screen** or by clicking it with a mouse.
4. Adjust the **Screen resolution** as required for each screen.

i Screen resolution has to be set manually: **Autodetect** does not function with more than 2 monitors.

5. Under **Advanced...**, enable **Detect refresh rate automatically** for each screen.
6. For each screen, select **Card 1** under **Graphic card**.
7. For each screen, select **Automatic** under **Monitor**.

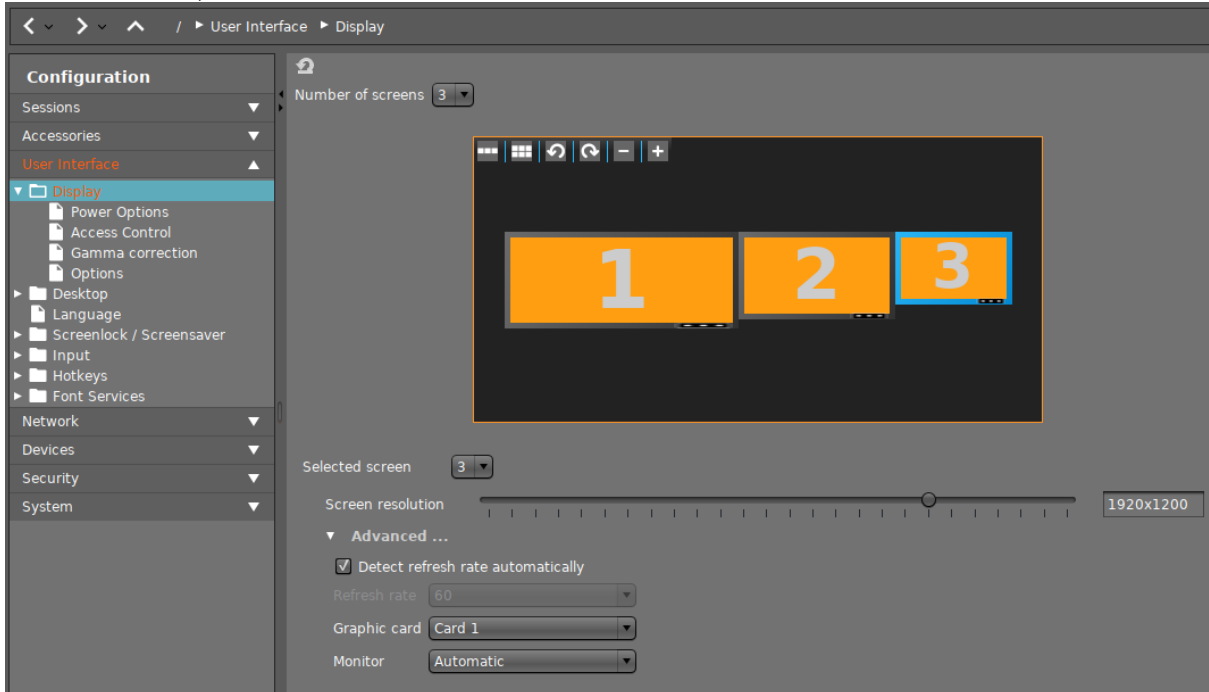

8. Click **Apply** or **OK** to save the settings.

⊗ After the screen configuration process has been completed, do not unplug your monitors, DP MST hub or its power supply cable. After the hotplug, the proper functioning is not guaranteed. To restore the functionality in this case, repeat the steps for the automatic screen configuration.

Manual Configuration

1. In IGEL Setup, go to **User Interface > Display**.
2. Under **Number of screens**, select **3**.

i If **Number of screens** is set to "1", the same content will be displayed on all three monitors.

3. Choose the screen under **Selected screen** or by clicking it with a mouse.
4. Adjust the **Screen resolution** as required for each screen.

i Screen resolution has to be set manually: **Autodetect** does not function with more than 2 monitors.

5. Under **Advanced...**, you can disable **Detect refresh rate automatically** and specify the desired **Refresh rate** for each screen.
6. For each screen, select **Card 1** under **Graphic card**.
7. Under **Monitor**, select:

- For monitor 1 (connected without the DP MST hub):
 - **DisplayPort** if you have connected the monitor to the DP port 1 (**D1**; nearest to the power jack); see the picture below:

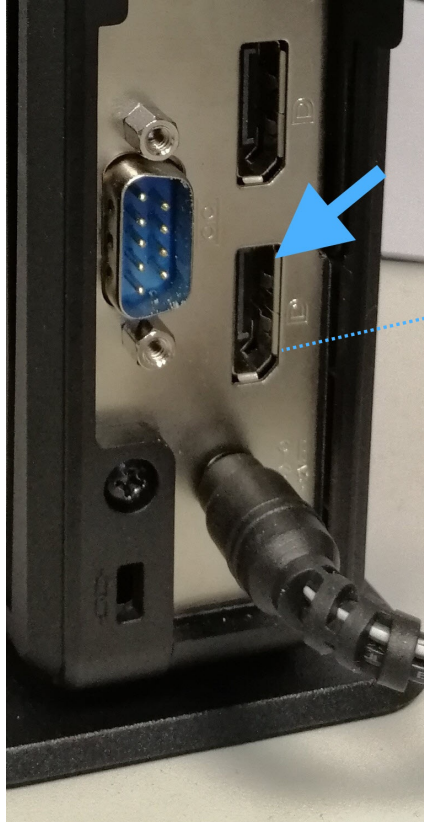

or

- **DisplayPort (II)** if you have connected the monitor to the DP port 2 (**D2**; farthest from the power jack); see the picture below:

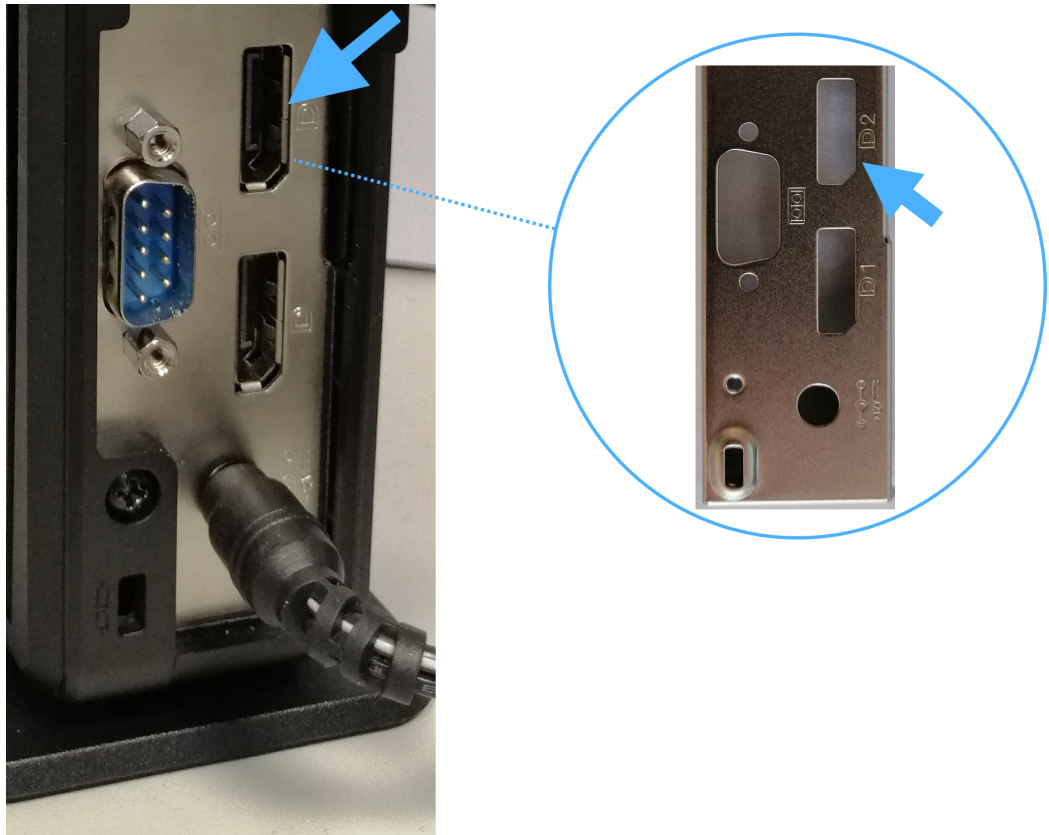

- For monitor 2 (connected with the DP MST hub, DP Out 1): **DisplayPort (IV)**.
- For monitor 3 (connected with the DP MST hub, DP Out 2): **DisplayPort (V)**.

8. Click **Apply** or **OK** to save the settings.

✘ After the screen configuration process has been completed, do not unplug the DP MST hub, its power supply cable or the both monitors connected to the hub. After the hotplug, the actual order of DP ports does not correspond anymore to the order defined in the IGEL Setup. To restore the functionality and clean up the screen configuration in this case, select **Automatic** for each monitor under IGEL Setup > **User Interface > Display > Monitor** and save the settings. After that, you can configure the screens manually again.

UD7 Model H860C: Multistream Transport (MST) / Monitor Daisy Chaining



Prerequisites

- IGEL UD7 model H860C
- IGEL OS 11.05.100 and higher
- Up to max. 4 monitors



Maximum Supported Resolution

- The max. total resolution of the monitors connected to the H860C device is 4x 4K @60 Hz.
- The max. total resolution of the monitors in the daisy chain cannot exceed 4K, i.e. max. 4K is divided between all monitors in the daisy chain, incl. the initial monitor connected to the H860C device.



USB Type-C Alternate Mode

- If a monitor is connected to the USB-C port (no matter directly or via a USB-to-DisplayPort adapter), DP 4 (**D4**) is disabled.
- After unplugging the monitor from the USB-C port, a monitor connected to DP 4 (**D4**) has to be replugged for the display to be detected again.

Connecting Monitors

To create a configuration with two monitors connected to DP 1 and DP 2 and two daisy-chained monitors connected via DP 3:

1. Connect the first monitor to DP 1 (**D1**).
2. Connect the second monitor to DP 2 (**D2**).
3. Connect the third monitor to DP 3 (**D3**).
4. Connect the fourth monitor to the monitor connected via DP 3.



All monitors in the daisy chain **except for the last monitor** must have DP mode enabled. You can usually enable the DP mode in the on-screen display (OSD) menu of your monitor.

Now it is necessary to configure the connected monitors. You have two options:

- Automatic screen configuration. In this case, the firmware recognizes and applies the screens automatically by default. See also [Automatic Configuration](https://kb.igel.com/en/igel-os/11.10.270/automatic-configuration)²⁰.
- Manual screen configuration. If the automatic configuration does not suit your needs, you can also configure screens manually. See also [Manual Configuration](https://kb.igel.com/en/igel-os/11.10.270/manual-configuration)²¹.

20. <https://kb.igel.com/en/igel-os/11.10.270/automatic-configuration>

21. <https://kb.igel.com/en/igel-os/11.10.270/manual-configuration>

✓ It is strongly recommended to use the automatic screen configuration.

Automatic Configuration

1. In IGEL Setup, go to **User Interface > Display**.
2. Under **Number of screens**, select "4".

ℹ If **Number of screens** is set to "1", the same content will be displayed on all four monitors.

3. Choose the screen under **Selected screen** or click the corresponding screen symbol.
4. Adjust the **Screen resolution** as required for each screen.

ℹ Screen resolution has to be set manually: **Autodetect** does not function with more than 2 monitors.

5. Under **Advanced...**, enable **Detect refresh rate automatically** for each screen.
6. For each screen, select **Card 1** under **Graphic card**.
7. For each screen, select **Automatic** under **Monitor**.
8. Click **Apply** or **OK** to save the settings.

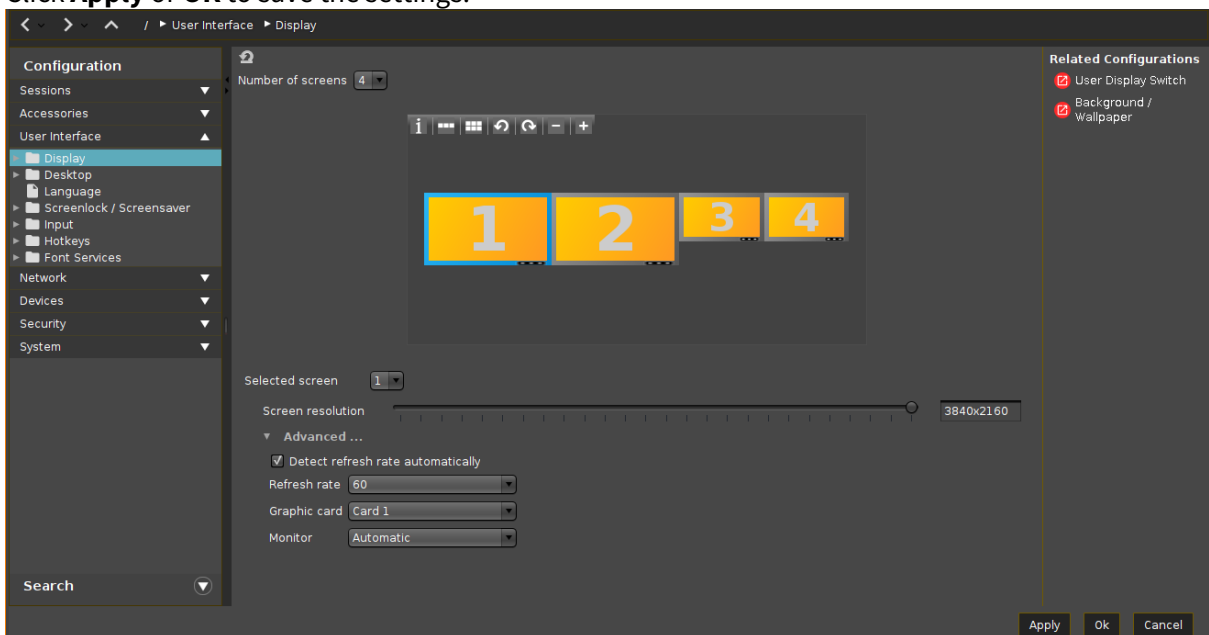

✗ After the screen configuration process has been completed, do not unplug your monitors. After a hotplug, proper functioning is not guaranteed. To restore the functionality in this case, repeat the steps for automatic configuration.

Manual Configuration

1. In IGEL Setup, go to **User Interface > Display**.
2. Under **Number of screens**, select "4".

i If **Number of screens** is set to "1", the same content will be displayed on all four monitors.

3. Choose the screen under **Selected screen** or click the correspondent screen symbol.
4. Adjust the **Screen resolution** as required for each screen.

i Screen resolution has to be set manually: **Autodetect** does not function with more than 2 monitors.

5. Under **Advanced...**, you can disable **Detect refresh rate automatically** and specify the desired **Refresh rate** for each screen.
6. For each screen, select **Card 1** under **Graphic card**.
7. Under **Monitor**, select:
 - For monitor 1 (connected to **D1**): **DisplayPort**
 - For monitor 2 (connected to **D2**): **DisplayPort (II)**
 - For monitor 3 (connected to **D3**): **DisplayPort (V)**
 - For monitor 4 (connected to monitor 3): **DisplayPort (VI)**

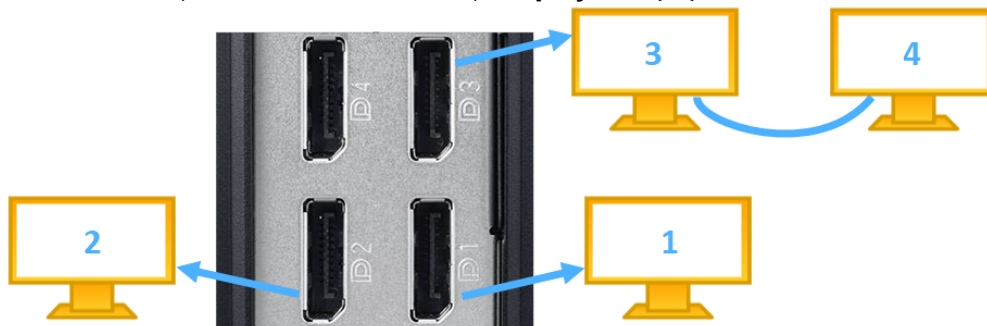

i **DP Number to Be Used for the "Monitor" Setting**

- For monitors that are NOT included in the daisy chain: The DP number must be the same as on the device.
- For the first monitor in the daisy chain, the DP numbering always starts with "5", i.e. **DisplayPort (V)**. For the further monitors in the daisy chain, the DP numbering continues with "6" and so on (max. up to "8", i.e. **DisplayPort (VIII)**).

8. Click **Apply** or **OK** to save the settings.

- ✘ After the screen configuration process has been completed, do not unplug the monitors or their power supply cables. After the hotplug, the actual order of DP ports does not correspond anymore to the order defined in the IGEL Setup. To restore the functionality and clean up the screen configuration in this case, select **Automatic** for each monitor under IGEL Setup > **User Interface > Display > Monitor** and save the settings. After that, you can configure the screens manually again.

VESA Mount for M250C, M350C, and H860C

These instructions apply to UD2 model M250C, UD3 model M350C, and UD7 model H860C.

With the IGEL VESA mount, you can mount the thin client on the back of your monitor to free up space on your desk.

IGEL VESA mount fits to all flat-panel monitors, complying with the VESA75 or VESA100 standard.

⊗ Do not use the IGEL VESA for mounting a thin client horizontally, e.g. at the underside of a desk! This would lead to overheating due to insufficient ventilation.

Components

The IGEL VESA mount consists of:

- two metal plates
- 4 x M3XL8 screws and 4 x gaskets for the thin client plate
- 4 x M4XL8 screws for the monitor plate

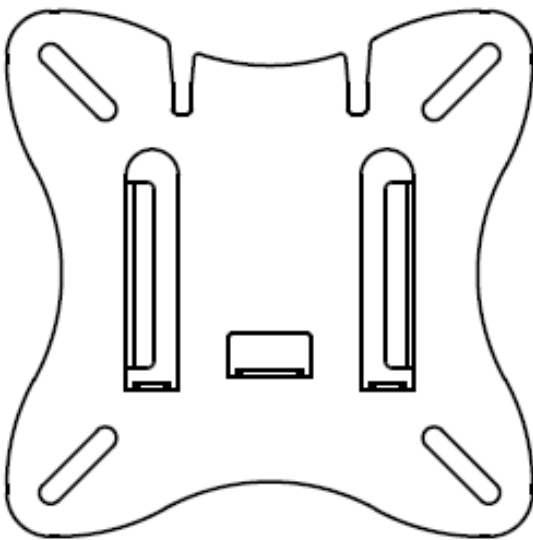

Monitor Plate

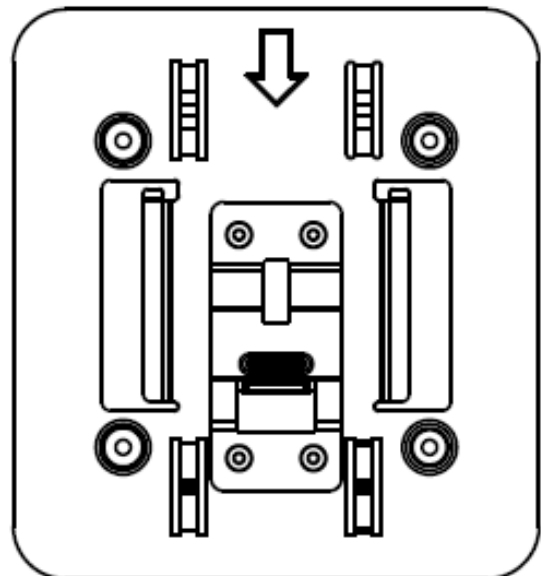

Thin Client Plate

i On delivery, the two plates are placed together. To separate them, push the monitor plate with a light raising movement in the direction of the arrow.

Mounting the Monitor Plate

→ Attach the VESA mount monitor plate with the screws to the back of your monitor, noting the correct alignment.

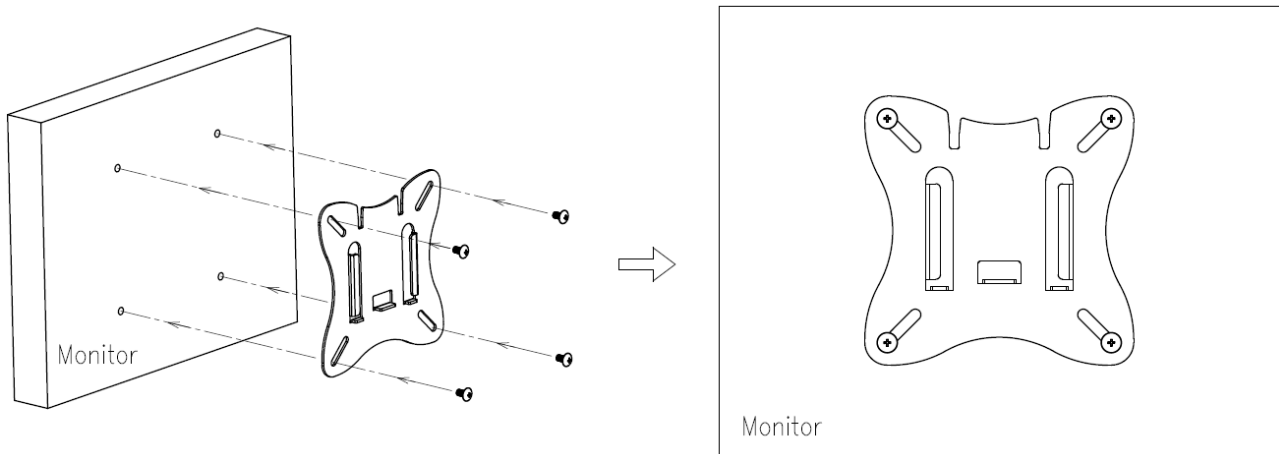

Mounting the Thin Client Plate

→ At the back side of the thin client plate, place the gaskets as shown on the picture:

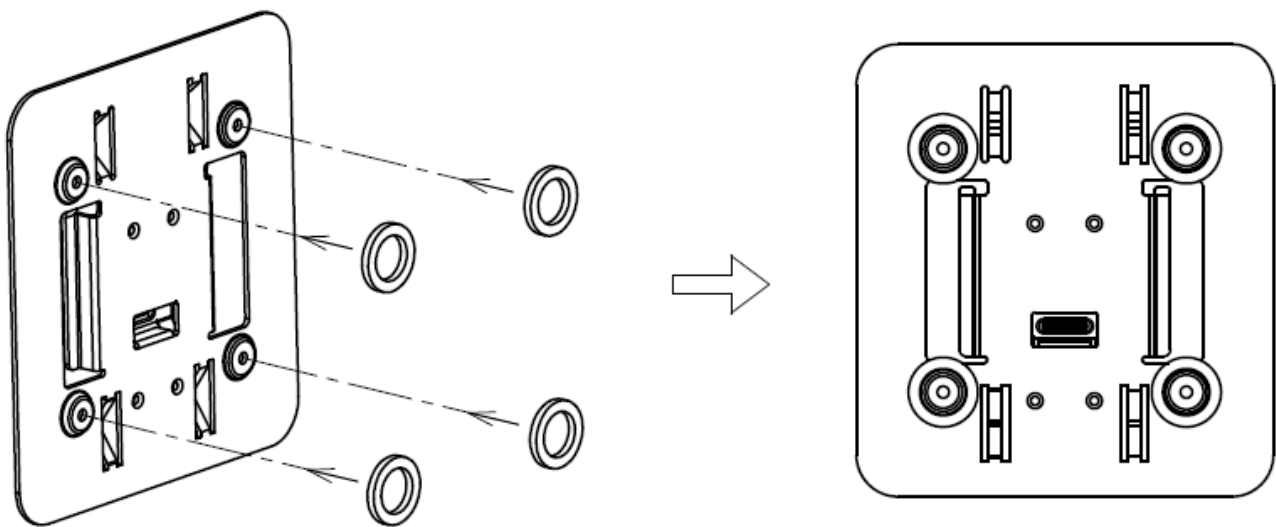

→ Insert the enclosed screws through the designated holes.

⊗ Use only the original screws. If you use longer screws, components in the housing can be damaged. If you use shorter screws, the VESA mount will not be fixed properly on the thin client.

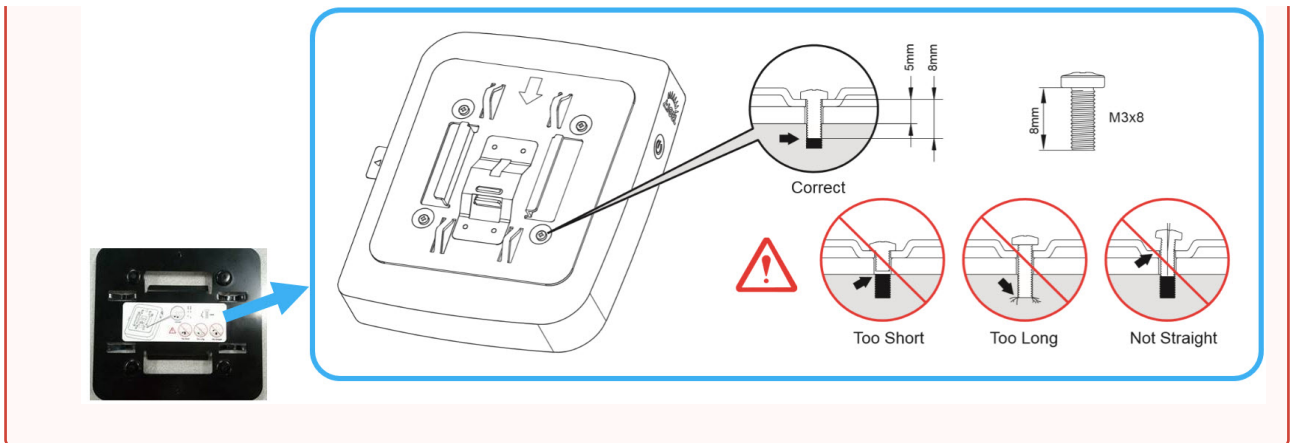

→ Screw them into the screw threads in the plastic wall of the thin client.

i Be careful to ensure that the arrow on the plate is pointing to the back connection site of the client.

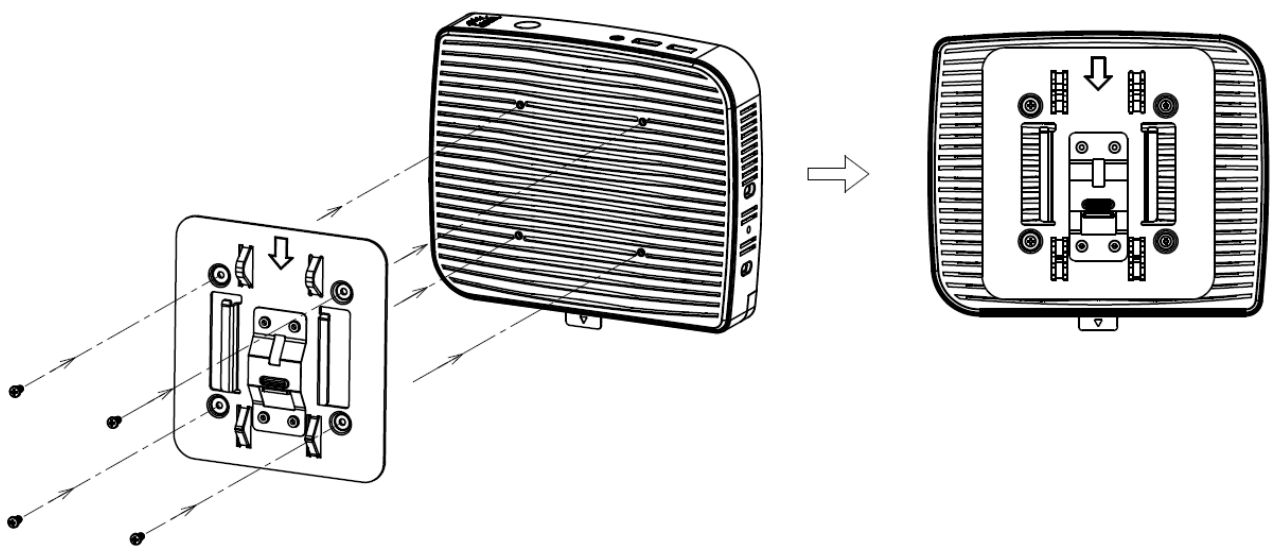

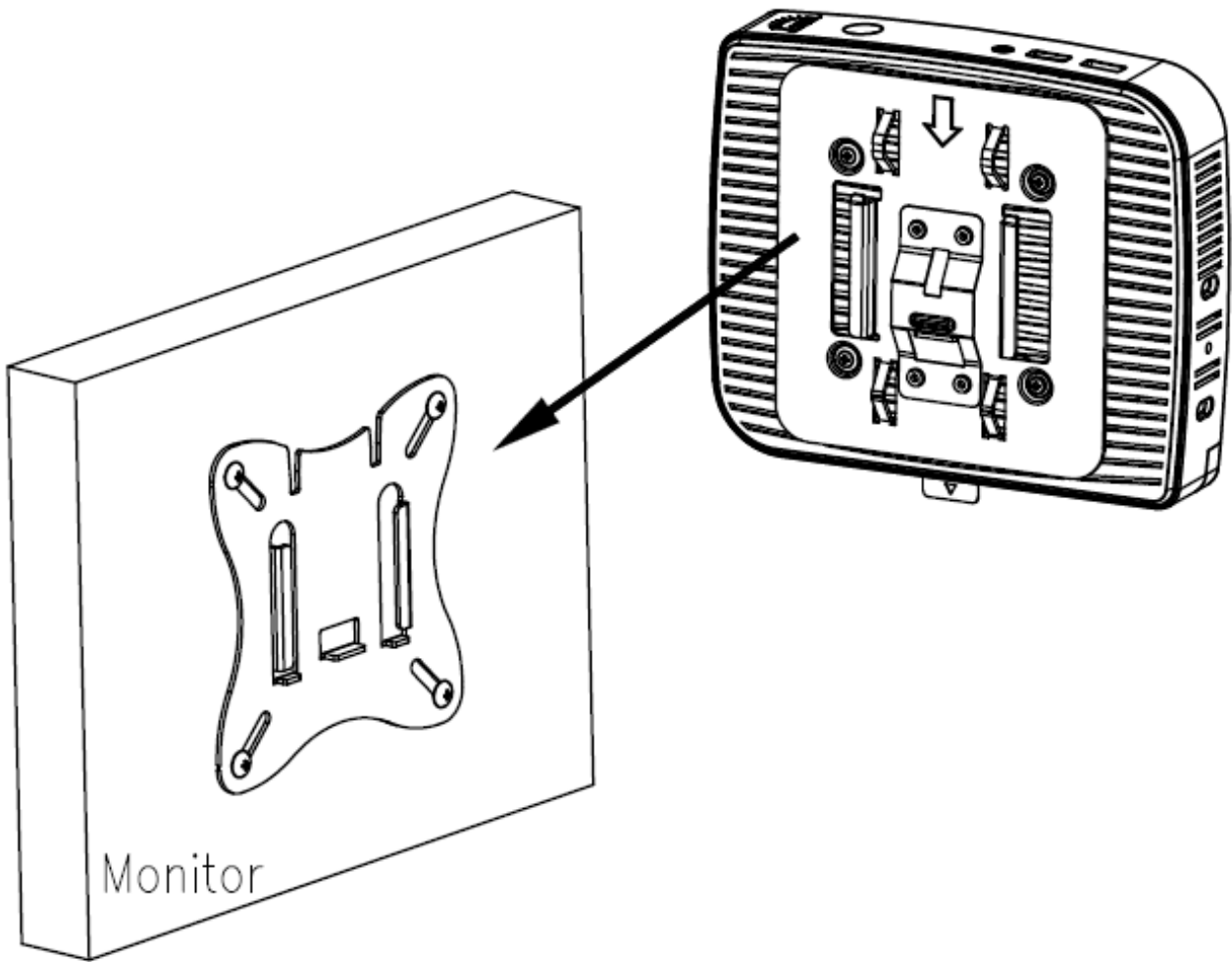

Pushing the Plates Together

- Plug in all cables before mounting the thin client to the monitor.
- Turn the thin client around so that the power button is facing upwards.

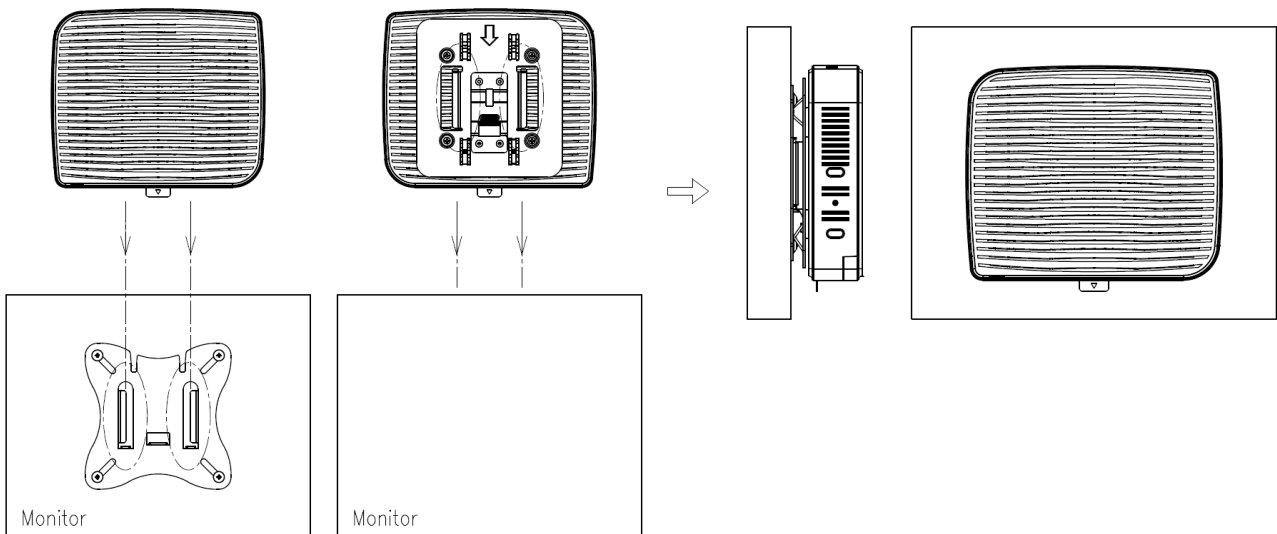

→ Slide the plate with the thin client from top to bottom in the guide slots of the monitor plate.



 To take the thin client off again, push it up gently. Be careful that you do not press the client against the monitor, otherwise the plates will not detach.



Hardware FAQs

- [Finding Out the IGEL Device Model \(see page 89\)](#)
- [Breakdown of IGEL Devices' Serial Number \(see page 93\)](#)
- [How Can I Update the BIOS Version? \(see page 95\)](#)
- [Defining MIME Types on Microsoft IIS to Distribute IGEL Firmware Updates \(see page 96\)](#)
- [Dual-Monitor Session for XenDesktop 7 \(see page 97\)](#)
- [Graphics on IGEL Devices \(see page 98\)](#)

Finding Out the IGEL Device Model

This is how you can find out the model of your IGEL UD device.

Option 1: On the Physical Device

→ Pull out the black label holder located at the rear of the device. The device model is specified under "Model Name".



Option 2: Locally in IGEL OS

1. Open the **About** window, accessible via the i-icon in the IGEL menu or in the *IGEL OS > IGEL OS Reference Manual > The IGEL OS Desktop > Application Launcher*

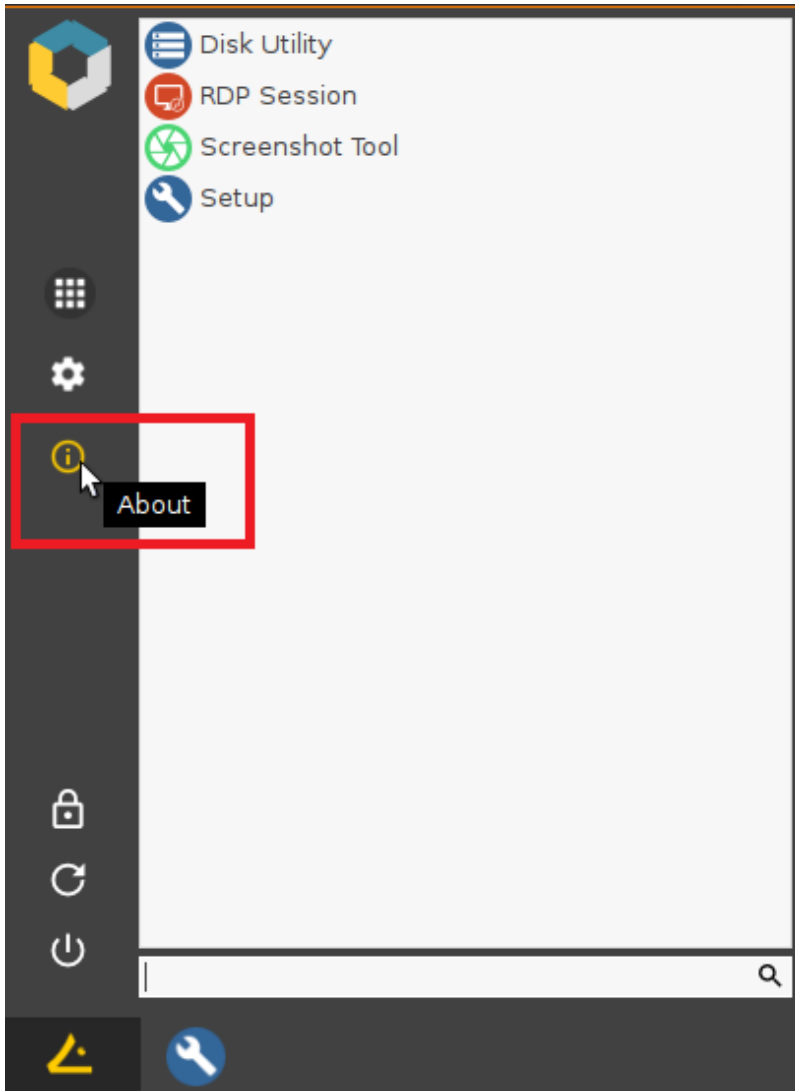

2. Scroll to the section **Hardware > Device Type**.

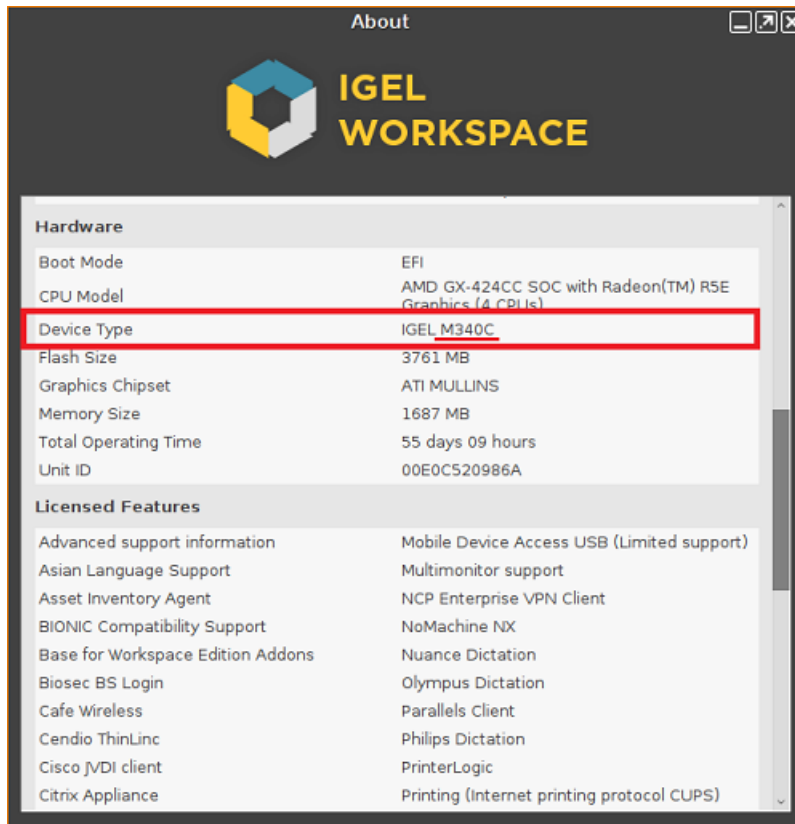

Option 3: Via the IGEL UMS

1. In the UMS Console, go to **Devices** and select the required device.
2. Under **Advanced System Information**, find the **Device Type** row.

The screenshot displays the IGEL Universal Management Suite 6 interface. The left sidebar shows a tree view of the system hierarchy, with 'TD-RD02' selected under 'Germany (2)'. The main panel shows the 'Advanced System Information' for the device 'TD-RD02'. A red box highlights the 'Advanced System Information' section header, and a red arrow points to the 'Device Type' field, which is 'IGEL_M340C'.

Attribute	Value
Unit ID	00E0C5209886A
MAC address	00:E0:C5:20:98:6A
Last IP	
Product	IGEL OS 11
Product ID	UD3-LX 51
Version	11.08.230.rc4.01
Firmware Description	
IGEL Cloud Gateway	
Expiration date of OS 10 maintenance subscription	
Last contact	Dec 7, 2022 12:30:17 PM
Last Boot Time	Dec 7, 2022 12:08 PM
Network Name (at Boot Time)	TD-RD02
Runtime since last Boot	00:22:16
Total Operating Time	341 days
Battery Level	
CPU Speed (MHz)	2400
CPU Type	AMD GX-424CC SOC with Radeon(TM) R5E Graphics
Flash Size (MB)	3762
Memory Size (MB)	1670
Network Speed	1000 Mbit/s
Duplex Mode	Full Duplex
Graphics Chipset 1	ATI MULLINS
Graphics Memory 1 (MB)	Dynamic
Graphics Chipset 2	
Graphics Memory 2 (MB)	
Device Type	IGEL_M340C

Breakdown of IGEL Devices' Serial Number

This overview of the serial number scheme is applicable to the new IGEL UD generation of devices: UD2 [M250C](#)²², UD3 [M350C](#)²³, and UD7 [H860C](#)²⁴.

Serial Number Breakdown

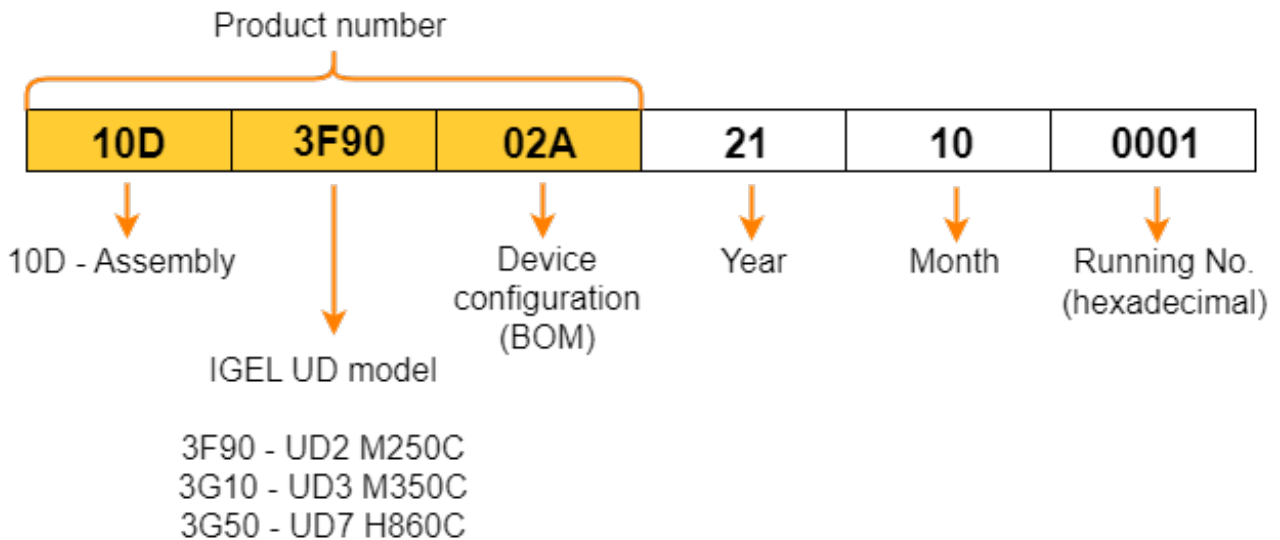

How Can I Find Out the Serial Number of My IGEL Device?

You can find the serial number of your IGEL device

- on the device label located at the rear of the device:



22. <https://kb.igel.com/knowledge-base-archive/current/>

23. <https://kb.igel.com/knowledge-base-archive/current/>

24. <https://kb.igel.com/knowledge-base-archive/current/>

- in the UMS Console: Go to **Devices**, select the required device, and expand **Advanced System Information**. At the bottom, you will see **Device Serial Number** field:

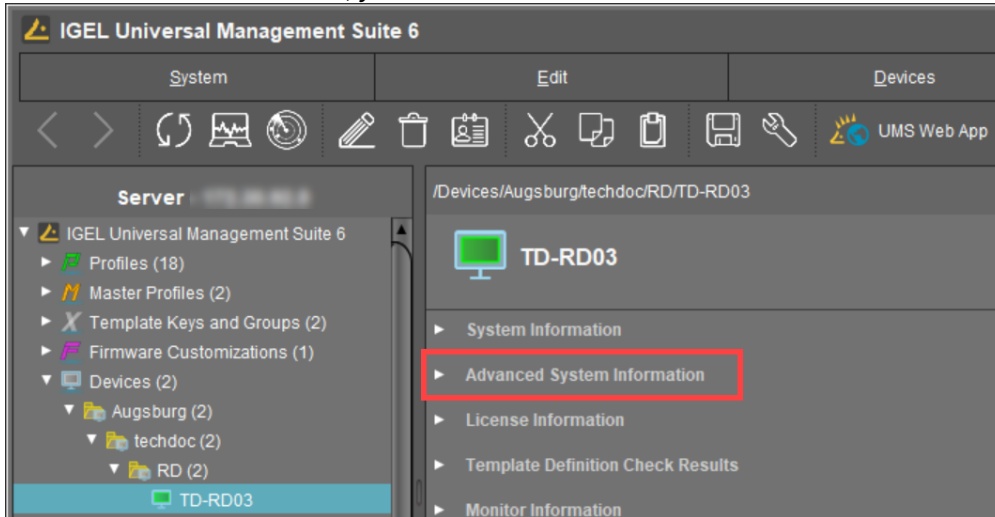

- in the BIOS in the **System Information** window: Press the [Del] key repeatedly during the reboot to access the BIOS, select **SCU / Setup Utility**, and press [F9].

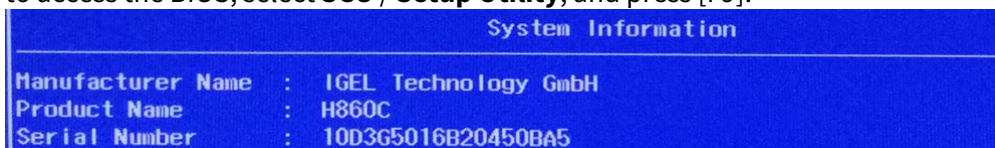

- via the local terminal with the command `cat /sys/devices/virtual/dmi/id/product_serial`



How Can I Update the BIOS Version?

Question

How can I update the BIOS version on my IGEL device?

Answer

If you do not have the required BIOS version and need to update your BIOS, please contact IGEL Support: <https://support.igel.com>²⁵. The IGEL support team will provide you with all necessary information.

25. <https://support.igel.com/>

Defining MIME Types on Microsoft IIS to Distribute IGEL Firmware Updates

Symptom

You are using Microsoft Internet Information Services IIS to provide firmware updates via HTTP for your IGEL devices (Windows or Linux based). When starting an update process, you receive an error message such as "File not available" or "File is not an archive", and the update process terminates unsuccessfully.

Problem

IIS does not offer files with unknown MIME types for the download and blocks the request coming from the device.

Solution

Make sure all files provided in the firmware update are added to the list of MIME types in IIS. Proceed as described in this [Microsoft support document](#)²⁶.

Add a new MIME type for files of extension (wildcard) '*' with a type of '**application/octet-stream**'. This will provide a default MIME type for all files that have not already had one and bypass the blocking.

✘ For security reasons, Microsoft does not recommend setting a wildcard that enables IIS to send out any kind of files. You may add every single file extension of your firmware update files to the list of MIME types instead.

26. <http://technet.microsoft.com/en-us/library/cc725608%28v=ws.10%29.aspx>

Dual-Monitor Session for XenDesktop 7

Symptom

XenDesktop 7 Windows desktop system or Windows server system only shows up on one display although you are using a dual-monitor setup.

Problem

By default, the StoreFront server is configured to start the VDI on one display only. This is by design but you should be able to maximize to both monitors after the session has started.

Solution

You need to edit the file `web.config` in the "StoreWeb" directory on your StoreFront server.

The default directory is:

```
INSTALLDIR\inetpub\wwwroot\citrix\Storeweb\
```

→ Set `showDesktopViewer=false`

After saving, your published desktop should expand over both screens.

Graphics on IGEL Devices

This document provides an overview of the graphics-related characteristics of IGEL devices.

	UD2	UD3	UD7
	M250C²⁷	M350C²⁸	H860C²⁹
Chipset	Intel HD Graphics	AMD Radeon™ Vega 3 Graphics	AMD Radeon™ Vega 8 Graphics
Video RAM	Dynamic shared memory 64 MB / 128 MB / 256 MB / 512 MB BIOS default option: 256 MB	Dynamic shared memory 256 MB / 512 MB / 1024 MB / 2048 MB / "auto" BIOS default option: "auto" (= 512 MB)	Dynamic shared memory 1024 MB / 2048 MB / 4096 MB BIOS default option: 2048 MB
Additional graphics card	-	-	-
Ports	2x DisplayPort 1.1a	2x DisplayPort 1.2	4x DisplayPort 1.2 1x DP 1.4 via USB 3.2 Gen 2 Type-C™ (Note: DP 4 is disabled when Type-C™ is connected to a monitor)
Max. supported resolutions (standard)	2560 x 1600 @60 Hz (dual view)	2x 4K @60 Hz	4x 4K @60 Hz incl. audio support (DP 1 – DP 4)

27. <https://kb.igel.com/knowledge-base-archive/current/>

28. <https://kb.igel.com/knowledge-base-archive/current/>

29. <https://kb.igel.com/knowledge-base-archive/current/>

	UD2	UD3	UD7
Max. supported resolutions (incl. hardware-accelerated video decoding)	2x WUXGA (1920 x 1200) or 1x WQHD (2560 x 1440)	2x 4K (Note: In case of the configured Multistream Transport (MST), the total resolution of the monitors connected via a DP MST hub cannot exceed 4K)	4x 4K (Note: For optimal 4K video decoding, you can set the VRAM in BIOS to 4 GB; default: 2 GB)
Supported video compression standard	H.264 H.265 (HEVC)	H.264 H.265 (HEVC)	H.264 H.265 (HEVC)
Multistream support (daisy chain)	-	optional with a DP MST hub (for up to 3 monitors operated at the same time)	
Type of DisplayPort-to-DVI adapter	active	- * (see page 99)	- ** (see page 99)

*



Tip

For UD3 devices M350C, IGEL recommends the following adapters:

- for connecting a monitor that requires a DVI port:
 - [Mini DisplayPort to 2 Port DVI-D MST Hub from LINDY³⁰](#) in combination with the [DisplayPort to Mini DisplayPort Adapter from LINDY³¹](#)
 - [DisplayPort to HDMI Active Adapter from Plugable³²](#) (requires an additional HDMI-to-DVI adapter cable)
- for configuring multistream transport (MST):
 - [DisplayPort 1.2a Splitter 2 Port from LINDY³³](#)

At lower resolutions (up to 1920 x 1200 @60 Hz), a passive DisplayPort-to-DVI adapter can also be used.

**

30. <https://www.lindy-international.com/Mini-DisplayPort-to-2-Port-DVI-D-MST-Hub.htm?websale8=ld0101.ld020102&pi=41731&ci=20>

31. <https://www.lindy-international.com/Mini-DP-to-DP-Adapter.htm?websale8=ld0101.ld020102&pi=41089&ci=80>

32. <https://plugable.com/products/dp-hdmi/>

33. <https://www.lindy-international.com/DisplayPort-1-2a-Splitter-2-Port.htm?websale8=ld0101.ld020102&pi=38402&ci=20>

**Tip**

For UD7 devices H860C, IGEL recommends the following adapters:

– for connecting a monitor that requires a DVI port:

- [Mini DisplayPort to 2 Port DVI-D MST Hub from LINDY³⁴](#) in combination with the [DisplayPort to Mini DisplayPort Adapter from LINDY³⁵](#)
- [DisplayPort to HDMI Active Adapter from Plugable³⁶](#) (requires an additional HDMI-to-DVI adapter cable)

At lower resolutions (up to 1920 x 1200 @60 Hz), a passive DisplayPort-to-DVI adapter can also be used.

For graphics-related characteristics of legacy IGEL devices, see [Graphics on Legacy IGEL Devices³⁷](#).

34. <https://www.lindy-international.com/Mini-DisplayPort-to-2-Port-DVI-D-MST-Hub.htm?websale8=ld0101.ld020102&pi=41731&ci=20>

35. <https://www.lindy-international.com/Mini-DP-to-DP-Adapter.htm?websale8=ld0101.ld020102&pi=41089&ci=80>

36. <https://plugable.com/products/dp-hdmi/>

37. <https://kb.igel.com/knowledge-base-archive/current/>

Hardware Troubleshooting

In the below articles you can find solutions to hardware related problems when the devices are used with IGEL.

- [Troubleshooting: Headphone Does Not Record through Back of the HP Elite t660 in IGEL OS 12 \(see page 102\)](#)

Troubleshooting: Headphone Does Not Record through Back of the HP Elite t660 in IGEL OS 12

You are running on IGEL OS 12 and insert the 3.5mm headphone jack on the back of the HP Elite t660 device. The microphone does not record.

Problem

The rear connection on the HP Elite t660 is line-out by default. The connection needs to be changed to line-in for recording.

Solution

→ To switch the rear side line-out to a line-in, enable the registry parameter **Switch back jack to line-in** under **system.sound_driver.snd_hda_intel.hp_t660_back_microphone**.

 You need to reboot the device to activate the setting.